

LEADER'S NEW TECHNOLOGIES

# CATALOG



INSURED FOR THE AMOUNT OF  
**50 000 000 RUB**  zetta®



# CONTENT



<b>LEMAX'S FACTORIES</b>	5
<b>HOW TO CHOOSE A BOILER?</b>	7
<b>FLOOR-STANDING GAS BOILERS:</b>	
Cast-Iron Gas Boilers of the OMEGA CI E Series	11
Cast-Iron Gas Boilers of the OMEGA CI Series	12
Steel Gas Boilers of the Prestige Series	13
Steel Gas Boilers of the Uno Series	17
Steel Gas Boilers of the OMEGA Series	21
Steel Gas Boilers of the Premium Series	25
Steel Gas Boilers of the Premium N Series	27
Steel Gas Boilers of the Perfect Series	33
Steel Gas Boilers of the Classic Series	37
Steel Gas Boilers of the Patriot Series with closed combustion chamber	43
Steel Gas Boilers of the CLEVER Series	45
Steel Gas Heating Facility Series Premier	47
Steel Gas Heating Facility Series Gazovik	51
Steel Gas Boilers of the CLEVER L Series	52

# CONTENT



## **WALL-HANG BOILERS:**

Gas Boilers of the Prime-V Series with a closed combustion chamber	57
Gas Boilers of the Prime-V HO Series with a closed combustion chamber	60
Gas Condensation Boiler of the Prime-C Series with a closed combustion chamber	64
Gas Boilers of the Prime-MA Series with an open combustion chamber	67
Electric Boilers of the PROPLUS Series	69

## **GAS WATER HEATER:**

Gas Water Heater LMX model 20M	73
Gas Water Heaters LMX models Classic-20/24/32	74
Gas Water Heaters LMX models Turbo-24/ Balans-24	75

## **RELATED PRODUCTS:**

External Fan of the Comfort and Comfort SE Series models S, M, L	79
External Fan of the Comfort and Comfort SE Series models XL, XXL	80
External Fan of the Comfort Series models Comfort 150, Comfort 180	81
Thrust Regulator REGULUS for solid fuel boiler	82
Room Thermostat CEWAL	82
Corrosion Inhibitor	82



# LEMAX'S FACTORIES



The Lemax enterprise is a specialized enterprise in the field of heating equipment. It has two powerful production centers to its credit: a plant for the production of household gas equipment and a plant for the production of steel panel radiators.

The main success that has been achieved is the recognition of the quality of Lemax products by customers. Currently, Lemax ranks 1st in the production of floor-standing gas boilers and 2nd place in the production of steel panel radiators (according to the Litvinchuk Marketing, 2022).



Today, Lemax's product portfolio consists of high-quality and in-demand products:

- energy-dependent outdoor gas boilers;
- non-volatile outdoor gas boilers;
- wall-hang gas boilers with an open combustion chamber;
- wall-hang gas boilers with a closed combustion chamber;
- electric boilers;
- flowing gas water heaters;
- steel panel radiators;
- related products and spare parts.

The plants use the best technological solutions of the industry, which make the products convenient and safe to use, easy to maintain, effective in application.

By purchasing Lemax equipment, the company forever becomes your reliable partner, and also guarantees high quality products, round-the-clock information and technical support, availability of components, spare parts.

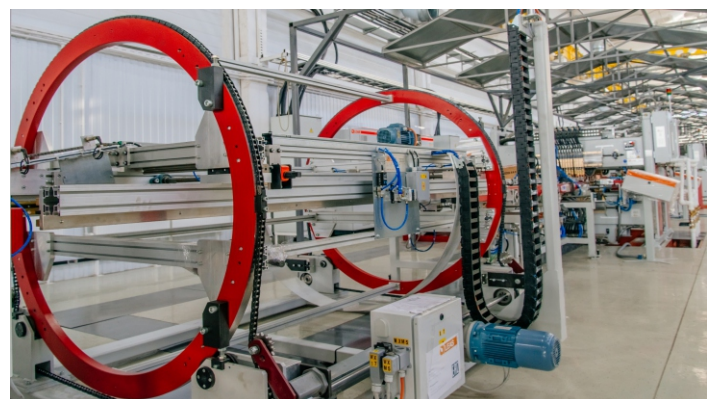



## LEMAX'S FACTORIES



The Company is a leader in the sphere of the innovative heating equipment production. Lemax boilers are the Russia's first injection torch boilers. Lemax boilers are made according to the advanced German technology which was specially developed for Lemax by the PROLean company. (PROLean company also developed technologies for Vaillant Group, BMW, AIRbus, Volkswagen and other manufacturing companies - world market leaders). The lean manufacturing system is successfully used at our works (a similar system functions at the Toyota Concern's enterprises). Lemax is the only heating equipment manufacturing Company, where robots – Italian and German high-tech machines, are employed.



One of the key factors of Lemax success is a powerful network of the maintenance service centers providing warranty post warranty maintenance and servicing in Russia and the CIS. The quality management system, certified in accordance with the International Standard ISO 9001:2015 is successfully applied by the Company.

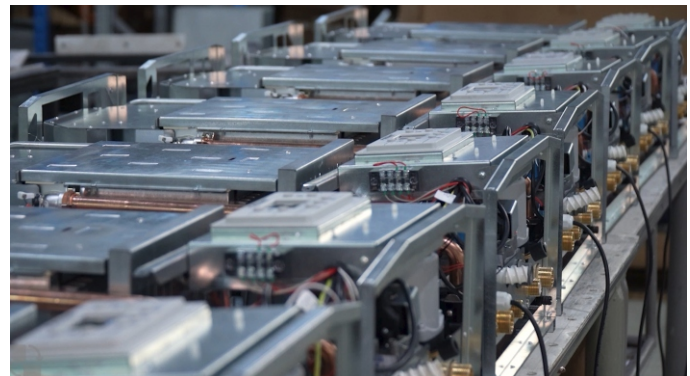

# HOW TO CHOOSE A BOILER??



One of the main roles in the heating of the house is played by the boiler. Competent design of the heating system and the correct installation of a gas boiler is the key to success in ensuring a comfortable stay in your home during the cold season. Therefore, before buying a boiler, it is necessary to decide on a number of issues that will help make the best choice.

## 1. Do you need a second circuit (hot water supply)??

Not all boilers have a built-in full-fledged hot water supply circuit or it is possible to connect an indirect heating tank. Perhaps you already have a flowing gas water heater that provides hot water supply. But if you are the owner of an electric water heater, then you should think about the fact that a boiler with a built-in second circuit in the near future will cost less than the amount of electricity that an electric water heater requires.

## 2. What is the capacity and volume of your heating system?

The easiest way to measure the volume of the heating system is to drain it and fill it again, observing the readings of the meter or water meter.

Each kW of boiler power can heat 15 liters of water in the system.

Next, it is required to calculate the power of the heating system, since each of the heating elements (radiators, heated towel rails, underfloor heating, etc.) has different power indicators. The power indicators of the devices can be found in the equipment passport or on the Internet. Thus, the power of the heating system is equal to the sum of the capacities of all heating devices.

## 3. Will external devices be connected to the boiler? Should the boiler be able to be remotely controlled from a smartphone?

If you want your boiler to work together with an indirect heating tank, or your heating system is equipped with a weather-dependent control system, and you can perform remote control from a smartphone, then you need an energy-dependent boiler. If these additional functions are not required, then a non-volatile boiler should be selected.





## HOW TO CHOOSE A BOILER?



### 4. How often are you ready to replace the boiler after the expiration of the service life?

Boilers, depending on the material of the heat exchanger (steel, cast iron, copper), are regulated by the manufacturer for a different period of its maximum operation. Lemax boilers with a steel heat exchanger have a service life of 15 years, with cast iron – 25 years, with copper – 12 years. After this period, the gas service may require its replacement.

### 5. A boiler is installed to replace the old one or this new heating system?

If the heating system is new, then it is necessary to pay attention to questions No. 1-4.

If the boiler is installed instead of the old one and the heating system has not changed dramatically (for example, the underfloor heating has not been added, an extension), then you can focus on the power of the previous boiler. But if you want to change a single-circuit boiler to a double-circuit boiler, then you need to remember that you will need to coordinate the technical conditions with the Gorgaz service.

### 6. What kind of smoke extraction system do you have?

The affiliation of the smoke removal system (forced or natural) and its dimension (diameter of the chimney), the type of boiler installation (floor or wall), the combustion chamber of the boiler (open or closed type) is determined by the project of the gas economy.

### Thus, in order to choose the right boiler, you need:

- determine the type of boiler (heat only or combi);
- find out the power and volume of the heating system;
- realize the need to connect an indirect heating tank, weather-dependent sensors, remote control systems;
- choose a comfortable boiler service life for yourself;
- apply to the gas industry.

**Any other questions?  
Visit website  
LEMAX-BOILER.COM,  
we will help you decide  
on the choice of  
the boiler series!**





# FLOOR-STANDING GAS BOILERS



**COME IN. CHOOSE. BUY! [LEMAX-BOILER.COM](http://LEMAX-BOILER.COM)**



# CAST-IRON GAS BOILERS OF THE OMEGA CI E SERIES



floor boilers

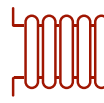

heat only

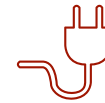

electric  
dependence



open combustion  
chamber

**4 MM**



cast-iron heat  
exchanger



natural gas



anti-corrosion  
protection

**3**  
years

warranty

Russian  
Control Board

- The model range is from 16 to 50 kW.
- Smooth flame modulation in a ratio of 1:3.
- The working pressure is up to 4 atm.
- The original 845 SIGMA safety automation.
- Remote monitoring and control using the built-in ModBus protocol or with a monitoring and control device using a potential-free (relay) type of contacts.
- Protection against overheating of the heat exchanger, interruption of traction, soot formation, boiler blowing.
- A needle-type heat exchanger using stainless steel turbulators to maintain the highest possible efficiency.
- Ease of maintenance of the boiler due to the use of easily removable cladding.

**5**  
**YEARS**  
**WARRANTY\***

\* when buying at an official point of sale LEMAX

## SAFETY AUTOMATION 845 SIGMA

- The new ignition system installed on the boilers ensures stable ignition of the gas-air mixture.
- An informative color display with a text description of the parameters in Russian reflects the user and service settings of the boiler.
- The boilers are resistant to voltage fluctuations (180 - 245 V) and gas pressure (6 - 25 mbar).
- Low noise level.

**NEW PRODUCT 2024**

# CAST-IRON GAS BOILERS OF THE OMEGA CI SERIES

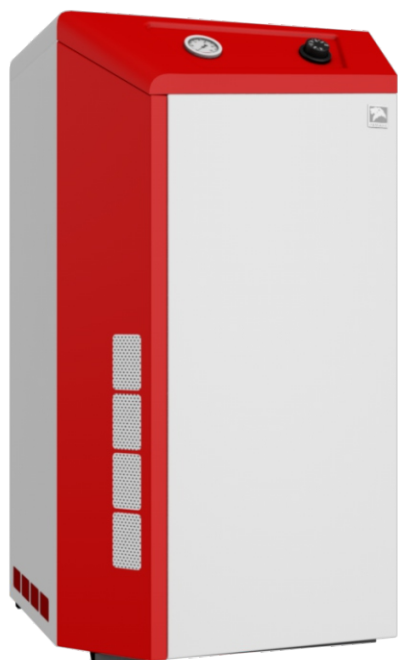

floor boilers

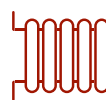

heat only



electric independence



open combustion chamber

**4 MM**



cast-iron heat exchanger



natural gas



anti-corrosion protection

**3**

years

warranty

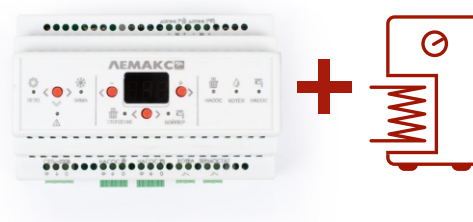

- Model range: from 16 to 50 kW.
- The working pressure is up to 4 atm.
- Protection against overheating of the heat exchanger, interruption of traction, soot formation, boiler blowing.
- A needle-type heat exchanger using stainless steel turbulators to maintain the highest possible efficiency.
- Ease of maintenance of the boiler due to the use of easily removable cladding.



## SAFETY AUTOMATION 820 NOVA

- The temperature controller is placed on the front panel of the boiler.
- Working with a monitoring and control device for remote monitoring and control of gas boilers and heating system indicators by connecting via a potential-free (relay) type of contacts.
- The possibility of connecting an indirect heating tank using a Lemax control device.
- The possibility of connecting a room thermostat to adjust the temperature inside the room with high accuracy.
- A smooth start system that provides acoustic comfort at the time of starting the boiler.



# STEEL GAS BOILERS OF THE PRESTIGE SERIES

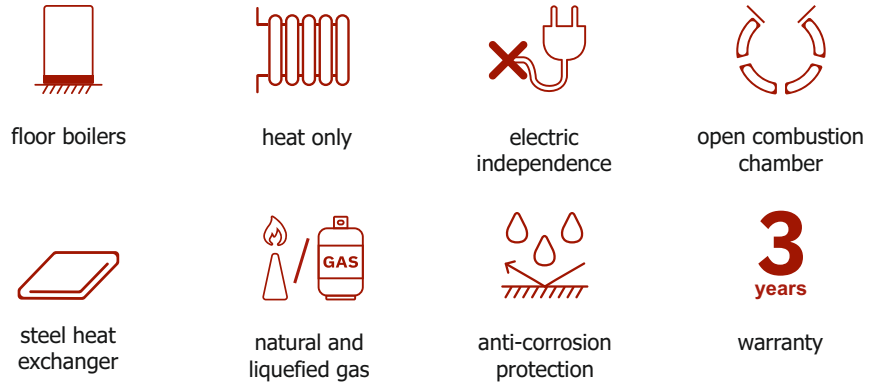

## SAFETY AUTOMATION 820 NOVA

- The model range is from 7,5 to 50 kW.
- Operating pressure:  
from 12,5 to 50 kW - up to 3 atm.,  
from 7,5 to 10 kW - up to 1 atm.
- Advanced safety systems against overheating of the heat exchanger, interruption of traction, soot formation, and blowing out of the boiler.
- The temperature regulator is located on the front panel of the boiler.
- Working in conjunction with monitoring and control device for remote monitoring and control of the gas boiler and heating system indicators through a mobile application.
- Possibility of connecting a room thermostat to regulate the indoor temperature with high precision.
- Work in conjunction with the Lemax External Fan of the Comfort SE series for forced exhaust gas removal in the absence of a stationary chimney.
- A soft start system that provides acoustic comfort at the time of boiler start-up.

# STEEL GAS BOILERS OF THE PRESTIGE SERIES



- Possibility of connecting to a vertical or horizontal chimney.

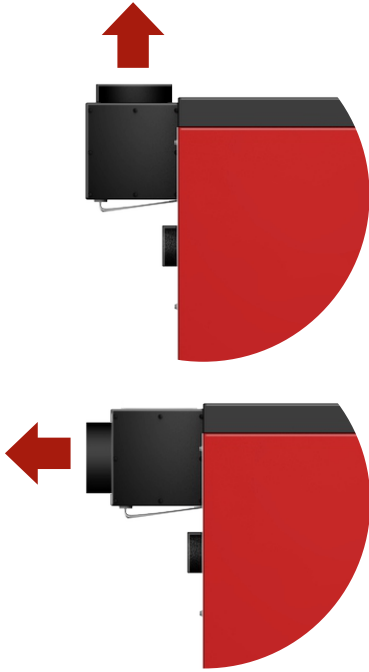

- Convenience of cleaning the boiler without disconnecting from the chimney due to the use of removable lining covers and a weight stabilizer.



## THE TRADITIONAL BOILERS

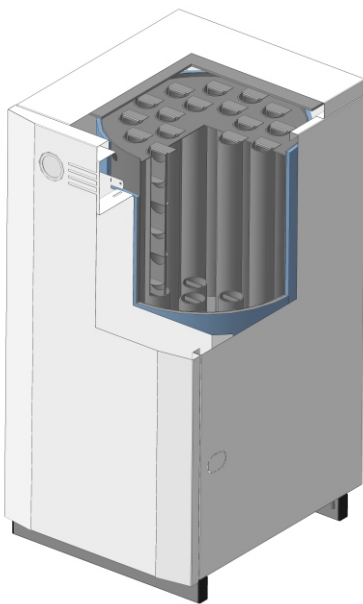

## BOILERS OF THE NEW GENERATION OF THE PRESTIGE SERIES

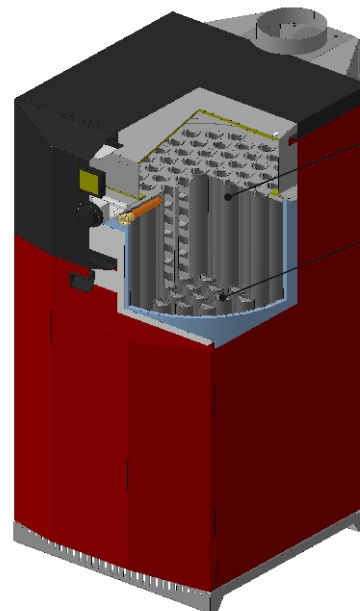

+ 20% heat exchange area

smoke channels x 2,5

# KEY BENEFITS OF STEEL GAS FLOOR-STANDING BOILERS OF THE PRESTIGE SERIES



## 1 20% REDUCTION IN HEATING COSTS DUE TO THE USE OF AN INNOVATIVE HEAT EXCHANGER DESIGN

- The heat exchange area was increased by 20% and the number of smoke channels was increased by 2,5 times to ensure the maximum possible efficiency at the lowest cost.

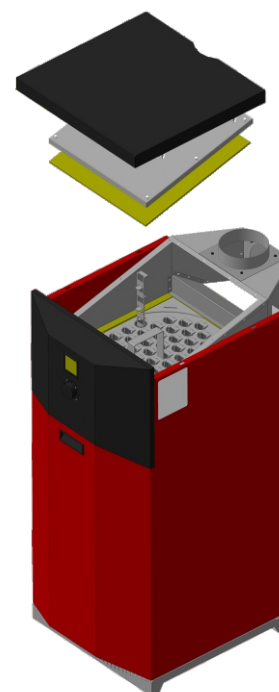

## 2 ADDITIONAL REDUCTION OF GAS CONSUMPTION BY 10% DUE TO THE USE OF A ROOM THERMOSTAT

- Possibility of connecting any relay room thermostat, with which you can have a comfortable temperature in the room regardless of changes the outside conditions.

**Built-in boiler thermostat**



**Room thermostat**

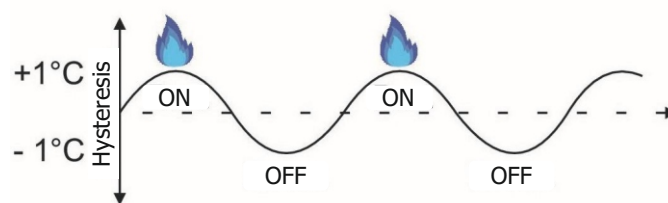
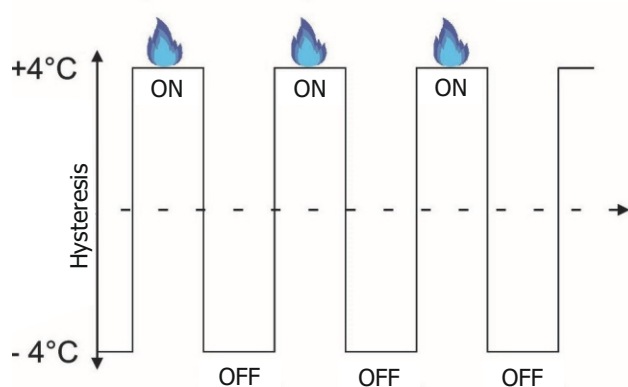

# STEEL GAS BOILERS OF THE PRESTIGE SERIES



Parameter	Prestige-7,5	Prestige-10	Prestige-12,5/ Prestige-12,5W	Prestige-16/ Prestige-16W	Prestige-20/ Prestige-20W	Prestige-25/ Prestige-25W	Prestige-30/ Prestige-30W	Prestige-35/ Prestige-35W	Prestige-40/ Prestige-40W	Prestige-50/ Prestige-50W
Type of gas burner unit	GGU-9NP	GGU-12NP	GGU-15NP	GGU-19NP	GGU-24NP	GGU-30NP	GGU-35NP	GGU-40	GGU-45	GGU-50
Gas valve	820 NOVA	820 NOVA	820 NOVA	820 NOVA	820 NOVA	820 NOVA	820 NOVA	820 NOVA	820 NOVA	820 NOVA
Nominal heating capacity, kW	7,5	10	12,5	16	20	25	30	35	40	50
Efficiency, % not less than	92*	92*	92*	92*	92*	92*	92*	92*	92*	92*
Approximate area of the heated room, m <sup>2</sup>	75**	100**	125**	160**	200**	250**	300**	350**	400**	400**
Heat exchanger volume, L	19,3	19,3	21	21	36,6	31,7	31,7	45,8	45,8	45,8
Natural gas consumption, m <sup>3</sup> /h										
- maximum	0,9	1,2	1,5	1,9	2,4	3,0	3,5	4,0	4,5	4,5
- average	0,45***	0,6***	0,75***	0,95***	1,2***	1,5***	1,75***	2,0***	2,25***	2,25***
Heating agent working pressure, mPa	0,1	0,1	0,3	0,3	0,3	0,3	0,3	0,3	0,3	0,3
Nominal gas natural pressure, Pa	1300									
Nominal gas liquefied pressure, Pa	1900-2100									
The range of discharge which ensures stable operation of the boiler, Pa	4-25	4-25	4-25	4-25	4-25	4-40	4-40	4-40	4-40	4-40
Smoke temperature °C, not less than	110	110	110	110	110	110	110	110	110	110
Maximum water temperature at boiler exit , °C	90	90	90	90	90	90	90	90	90	90
Hot water supply loop output over 25 °C delta, L/min	-	-	-/4****	-/5****	-/6****	-/7****	-/8****	-/9****	-/10****	-/11****
Chimney connection, mm	100	100	130	130	130	130	130	140	140	140
Gas connection diameter, inch	½"	½"	½"	½"	½"	½"	¾"	¾"	¾"	¾"
Connection diameter of heating, inch	1 ½"	1 ½"	2"	2"	2"	2"	2"	2"	2"	2"
Dimensions, mm:										
- height	835	835	865	865	1065	1065	1065	1112	1112	1235
- width	324	324	412	412	465	465	465	528	528	560
- depth	570	570	615	615	690	690	690	760	760	876
Mass not more than, kg										
- net	42	42	60/62	60/62	76/79	79/82	79/82	107/111	107/111	132
- gross	44	44	62/64	62/64	86/89	89/92	89/92	118/122	118/122	145

1 PA = 0,102 mm of water column

\* - the result was obtained in laboratory conditions

\*\* - the maximum area of the heated room is determined in the project for the heating system, taking into account all heat losses of the building

\*\*\* - the result was obtained by calculation in the laboratory

\*\*\*\* - when the heating system is switched off, the maximum boiler power, the inlet water temperature is not less than 15 °C, as well as the coolant temperature is not less than 85 °C

# STEEL GAS BOILERS OF THE UNO SERIES

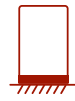
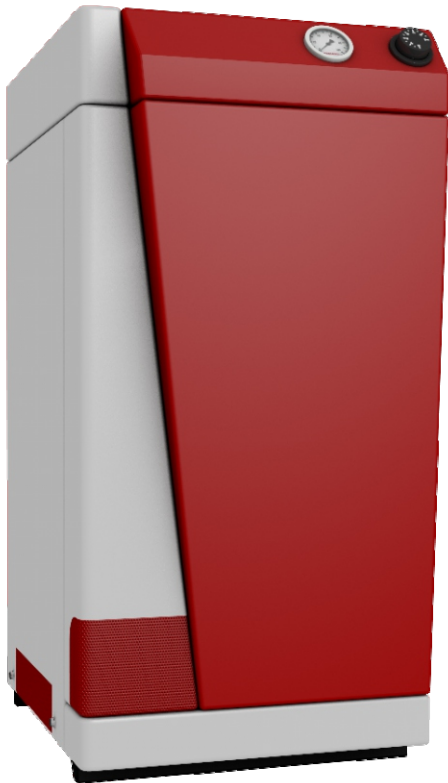

floor boilers

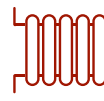

heat only



electric  
independence



open combustion  
chamber



steel heat  
exchanger



natural and  
liquefied gas



anti-corrosion  
protection

**3**  
years

warranty



## SAFETY AUTOMATION 820 NOVA

- The model range is from 7,5 to 50 kW.
- Operating pressure:  
from 12,5 to 50 kW - up to 3 atm.,  
from 7,5 to 10 kW - up to 1 atm.
- Advanced safety systems against overheating of the heat exchanger, interruption of traction, soot formation, and blowing out of the boiler.
- The temperature regulator is located on the front panel of the boiler.
- Working in conjunction with monitoring and control device for remote monitoring and control of the gas boiler and heating system indicators through a mobile application.
- Possibility of connecting a room thermostat to regulate the indoor temperature with high precision.
- Work in conjunction with the Lemax External Fan of the Comfort SE series for forced exhaust gas removal in the absence of a stationary chimney.
- A soft start system that provides acoustic comfort at the time of boiler start-up.

# STEEL GAS BOILERS OF THE PRESTIGE SERIES



- Possibility of connecting to a vertical or horizontal chimney.

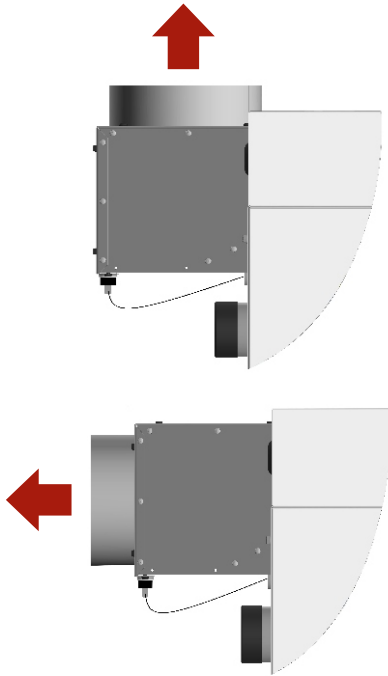

- Convenience of cleaning the boiler without disconnecting from the chimney due to the use of removable lining covers and a weight stabilizer.

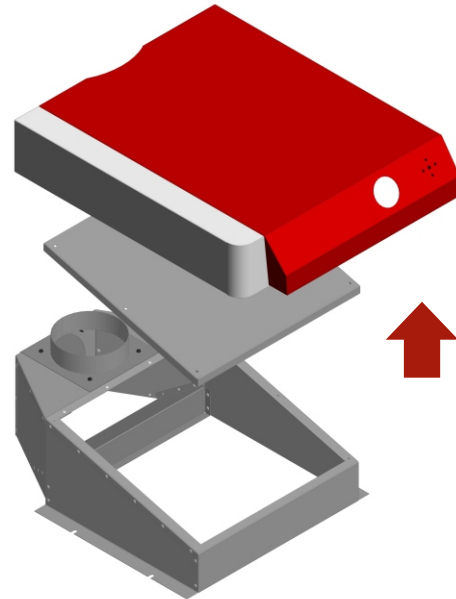

## THE TRADITIONAL BOILERS

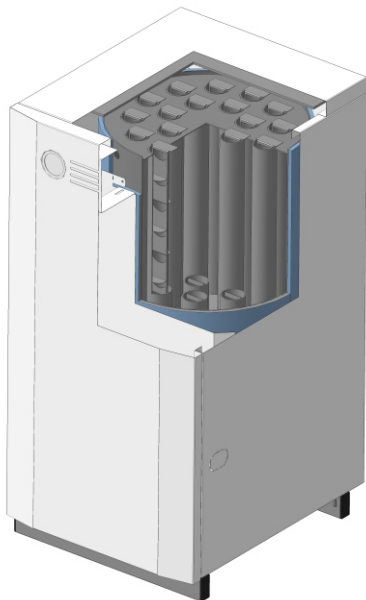

## BOILERS OF THE NEW GENERATION OF THE UNO SERIES

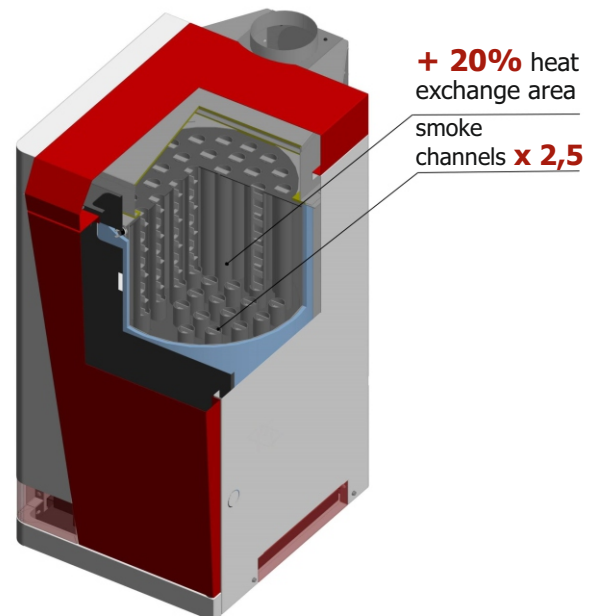



# KEY BENEFITS OF STEEL GAS FLOOR-STANDING BOILERS OF THE UNO SERIES



## 1 20% REDUCTION IN HEATING COSTS DUE TO THE USE OF AN INNOVATIVE HEAT EXCHANGER DESIGN

- The heat exchange area was increased by 20% and the number of smoke channels was increased by 2,5 times to ensure the maximum possible efficiency at the lowest cost.

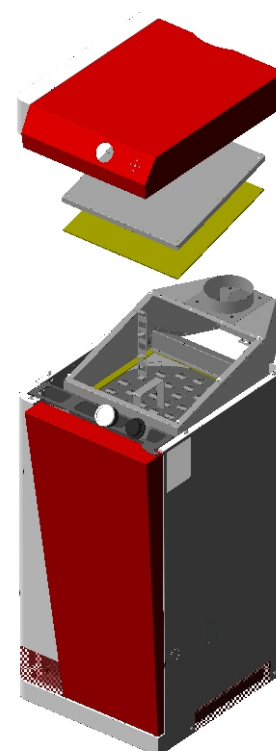

## 2 ADDITIONAL REDUCTION OF GAS CONSUMPTION BY 10% DUE TO THE USE OF A ROOM THERMOSTAT

- Possibility of connecting any relay room thermostat, with which you can have a comfortable temperature in the room regardless of changes the outside conditions.

**Built-in boiler thermostat**

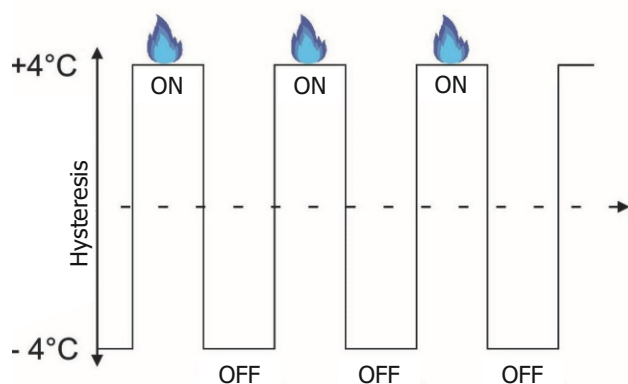

**Room thermostat**

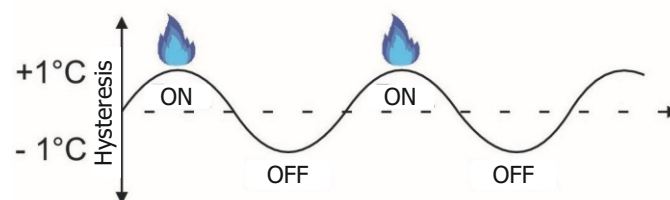

# STEEL GAS BOILERS OF THE PRESTIGE SERIES



Parameter	UNO-7,5	UNO-10	UNO-12,5/ UNO-12,5W	UNO-16/ UNO-16W	UNO-20/ UNO-20W	UNO-25/ UNO-25W	UNO-30/ UNO-30W	UNO-35/ UNO-35W	UNO-40/ UNO-40W	UNO-50/ UNO-50W
Type of gas burner unit	GGU-9NP	GGU-12NP	GGU-15NP	GGU-19NP	GGU-24NP	GGU-30NP	GGU-35NP	GGU-40	GGU-45	GGU-50
Gas valve	820 NOVA	820 NOVA	820 NOVA	820 NOVA	820 NOVA	820 NOVA	820 NOVA	820 NOVA	820 NOVA	820 NOVA
Nominal heating capacity, kW	7,5	10	12,5	16	20	25	30	35	40	50
Efficiency, % not less than	92*	92*	92*	92*	92*	92*	92*	92*	92*	92*
Approximate area of the heated room, m <sup>2</sup>	75**	100**	125**	160**	200**	250**	300**	350**	400**	500**
Heat exchanger volume, L	19,3	19,3	21	21	36,6	31,7	31,7	45,8	45,8	63
Natural gas consumption, m <sup>3</sup> /h										
- maximum	0,9	1,2	1,5	1,9	2,4	3,0	3,5	4,0	4,5	5,5
- average	0,45***	0,6***	0,75***	0,95***	1,2***	1,5***	1,75***	2,0***	2,25***	2,75***
Heating agent working pressure, mPa	0,1	0,1	0,3	0,3	0,3	0,3	0,3	0,3	0,3	0,3
Nominal gas natural pressure, Pa	1300									
Nominal gas liquefied pressure, Pa	1900-2100									
The range of discharge which ensures stable operation of the boiler, Pa	4-25	4-25	4-25	4-25	4-25	4-40	4-40	4-40	4-40	4-40
Smoke temperature °C, not less than	110	110	110	110	110	110	110	110	110	110
Maximum water temperature at boiler exit, °C	90	90	90	90	90	90	90	90	90	90
Hot water supply loop output over 25 °C delta, L/min	-	-	-/4****	-/5****	-/6****	-/7****	-/8****	-/9****	-/10****	-/11****
Chimney connection diameter, mm	100	100	130	130	130	130	130	140	140	200
Gas connection diameter, inch	½"	½"	½"	½"	½"	½"	¾"	¾"	¾"	¾"
Connection diameter of heating, inch	1 ½"	1 ½"	2"	2"	2"	2"	2"	2"	2"	2"
Dimensions, mm:										
- height	836	836	867	867	1060	1060	1060	1113	1113	1230
- width	330	330	417	417	470	470	470	530	530	560
- depth	620	620	650	650	722	722	722	785	785	893
Mass not more than, kg										
- net	46	46	64/66	64/66	81/84	84/87	84/87	113/117	113/117	118/123
- gross	48	48	66/68	66/68	91/94	94/97	94/97	124/128	124/128	134/138

1 Pa = 0,102 mm of water column

\* - the result was obtained in laboratory conditions

\*\* - the maximum area of the heated room is determined in the project for the heating system, taking into account all heat losses of the building

\*\*\* - the result was obtained by calculation in the laboratory

\*\*\*\* - when the heating system is switched off, the maximum boiler power, the inlet water temperature is not less than 15 °C, as well as the coolant temperature is not less than 85 °C



# STEEL GAS BOILERS OF THE OMEGA SERIES

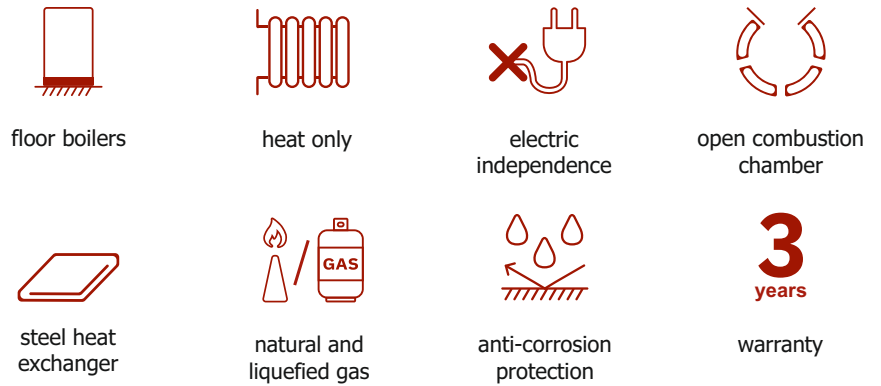
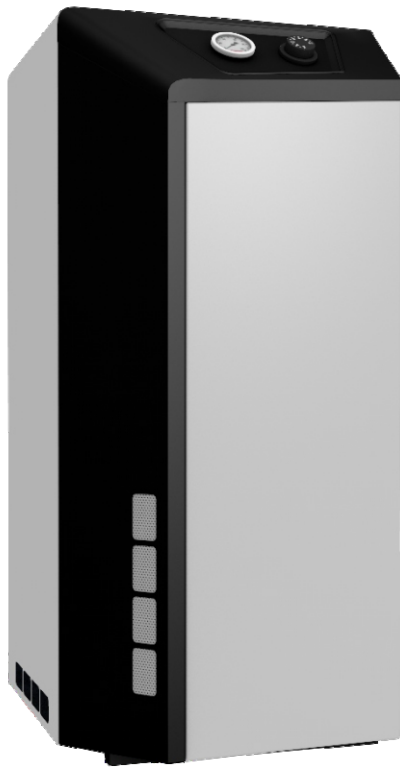

## SAFETY AUTOMATION 820 NOVA

- The model range is from 12,5 to 50 kW.
- Operating pressure - up to 3 atm.
- Advanced safety systems against overheating of the heat exchanger, interruption of traction, soot formation, and blowing out of the boiler.
- The temperature regulator is located on the front panel of the boiler.
- Working in conjunction with monitoring and control device for remote monitoring and control of the gas boiler and heating system indicators through a mobile application.
- Possibility of connecting a room thermostat to regulate the indoor temperature with high precision.
- Work in conjunction with the Lemax External Fan of the Comfort SE series for forced exhaust gas removal in the absence of a stationary chimney.
- A soft start system that provides acoustic comfort at the time of boiler start-up.

# STEEL GAS BOILERS OF THE OMEGA SERIES



- Possibility of connecting to a vertical or horizontal chimney.

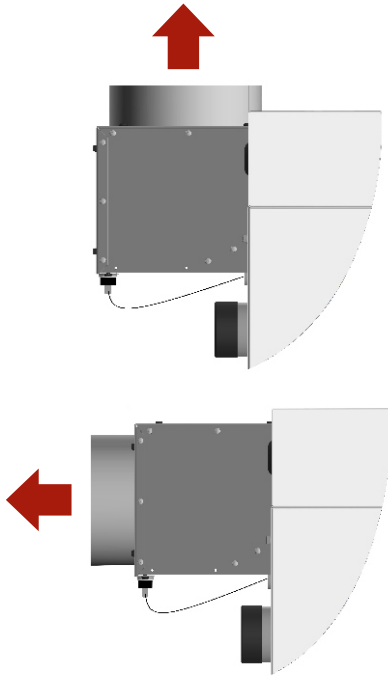

- Convenience of cleaning the boiler without disconnecting from the chimney due to the use of removable lining covers and a weight stabilizer.

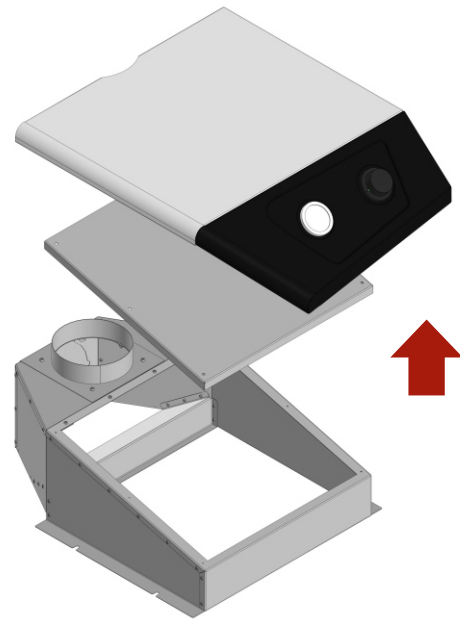

## THE TRADITIONAL BOILERS

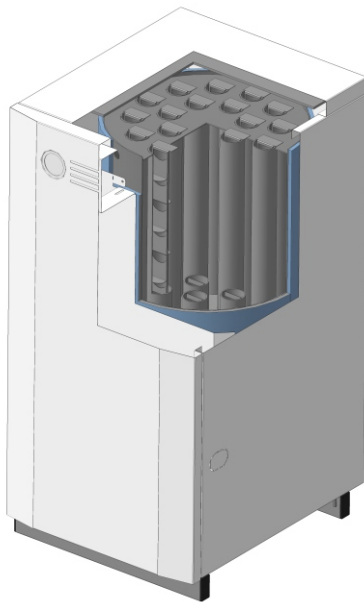

## BOILERS OF THE NEW GENERATION OF THE OMEGA SERIES

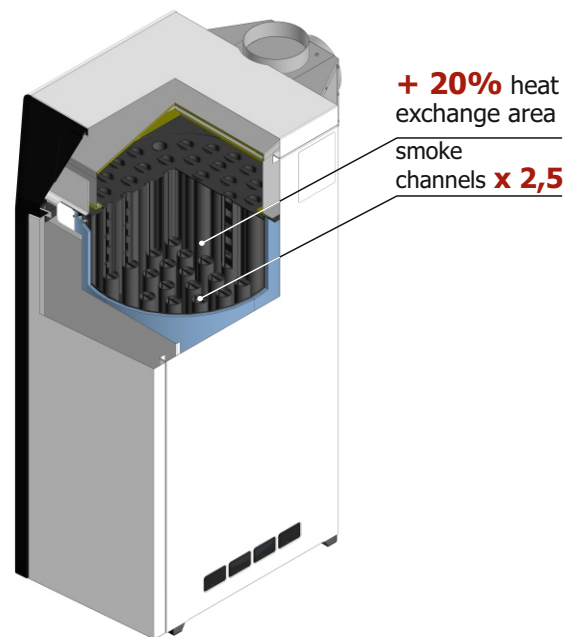

# KEY BENEFITS OF STEEL GAS FLOOR-STANDING BOILERS OF THE OMEGA SERIES



## 1 20% REDUCTION IN HEATING COSTS DUE TO THE USE OF AN INNOVATIVE HEAT EXCHANGER DESIGN

- The heat exchange area was increased by 20% and the number of smoke channels was increased by 2,5 times to ensure the maximum possible efficiency at the lowest cost.

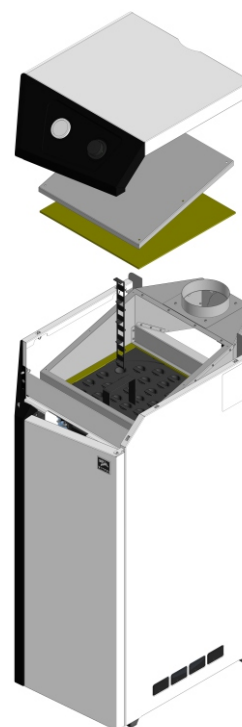

## 2 ADDITIONAL REDUCTION OF GAS CONSUMPTION BY 10% DUE TO THE USE OF A ROOM THERMOSTAT

- Possibility of connecting any relay room thermostat, with which you can have a comfortable temperature in the room regardless of changes the outside conditions.

### Built-in boiler thermostat

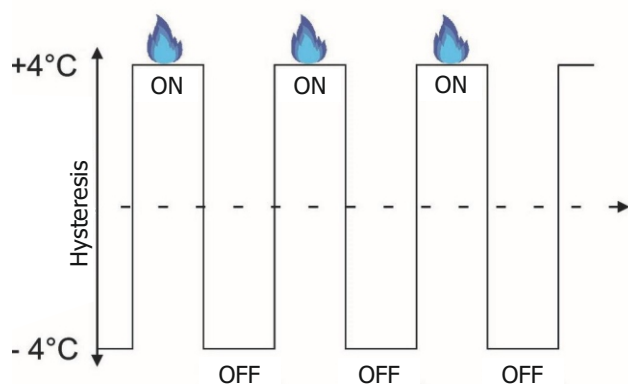
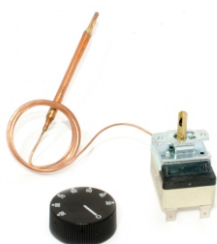

### Room thermostat

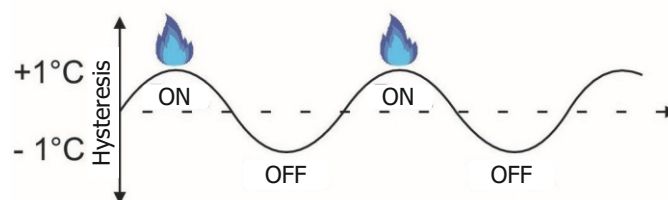

# STEEL GAS BOILERS OF THE OMEGA SERIES



Наименование параметров	OMEGA-12,5	OMEGA-16	OMEGA-20	OMEGA-25	OMEGA-30	OMEGA-35	OMEGA-40	OMEGA-50
Type of gas burner unit	GGU-15NP	GGU-19NP	GGU-24NP	GGU-30NP	GGU-35NP	GGU-40	GGU-45	GGU-50
Gas valve	820 NOVA	820 NOVA	820 NOVA	820 NOVA	820 NOVA	820 NOVA	820 NOVA	820 NOVA
Nominal heating capacity, kW	12,5	16	20	25	30	35	40	50
Efficiency, % not less than	92*	92*	92*	92*	92*	92*	92*	92*
Approximate area of the heated room, m <sup>2</sup>	125**	160**	200**	250**	300**	350**	400**	500**
Heat exchanger volume, L	21	21	36,6	31,7	31,7	45,8	45,8	63
Natural gas consumption, m <sup>3</sup> /h								
- maximum	1,5	1,9	2,4	3,0	3,5	4,0	4,5	5,5
- average	0,75***	0,95***	1,2***	1,5***	1,75***	2,0***	2,25***	2,75***
Heating agent working pressure, mPa	0,3	0,3	0,3	0,3	0,3	0,3	0,3	0,3
Nominal gas natural pressure, Pa	1300							
Nominal gas liquefied pressure, Pa	1900-2100							
The range of discharge which ensures stable operation of the boiler, Pa	4-25	4-25	4-25	4-40	4-40	4-40	4-40	4-40
Smoke temperature °C, not less than	110	110	110	110	110	110	110	110
Maximum water temperature at boiler exit, °C	90	90	90	90	90	90	90	90
Chimney connection diameter, mm	130	130	130	130	130	140	140	200
Gas connection diameter, inch	¾"	¾"	¾"	¾"	¾"	¾"	¾"	¾"
Connection diameter of heating, inch	2"	2"	2"	2"	2"	2"	2"	2"
Dimensions, mm:								
- height	868	868	1060	1060	1060	1120	1120	1235
- width	420	420	472	472	472	536	536	566
- depth	627	627	690	690	690	758	758	870
Mass not more than, kg								
- net	64	64	81	84	84	113	113	137
- gross	66	66	91	94	94	124	124	142

1 Pa = 0,102 mm of water column

\* - the result was obtained in laboratory conditions

\*\* - the maximum area of the heated room is determined in the project for the heating system, taking into account all heat losses of the building

\*\*\* - the result was obtained by calculation in the laboratory

# STEEL GAS BOILERS OF THE PREMIUM SERIES



floor boilers



heat only/  
combi



electric  
independence



open combustion  
chamber



steel heat  
exchanger



natural and  
liquefied gas



anti-corrosion  
protection

**3**  
years

warranty

- The model range is from 7,5 to 30 kW.
- Maximum efficiency due to an increase in the heat exchange area and the use of an innovative design of turbulators for maximum delay of exhaust gases.
- Operating pressure:  
from 12,5 to 30 kW - up to 3 atm, from 7,5 to 10 kW - up to 1 atm.
- Improved safety systems against overheating of the heat exchanger, interruption of traction, soot formation, boilerblowing.
- Ease of maintenance of the boiler due to the use of an easily removable top panel.

Parameter	Premium-7,5	Premium-10	Premium-12,5/ Premium-12,5W	Premium-16/ Premium-16W	Premium-20/ Premium-20W	Premium-25/ Premium-25W	Premium-30/ Premium-30W
Type of gas burner unit	GGU-9	GGU-12	GGU-15	GGU-19	GGU-24	GGU-30	GGU-35
Gas valve	630 EUROSIT	630 EUROSIT	630 EUROSIT	630 EUROSIT	630 EUROSIT	710 MINISIT	710 MINISIT
Nominal heating capacity, kW	7,5	10	12,5	16	20	25	30
Efficiency, % not less than	90*	90*	90*	90*	90*	90*	90*
Approximate area of the heated room, m <sup>2</sup>	75**	100**	125**	160**	200**	250**	300**
Heat exchanger volume, L	16,5	16,5	24,5	24,5	43	41	41
Natural gas consumption, m <sup>3</sup> /h - maximum - average	0,9 0,45***	1,2 0,6***	1,5 0,75***	1,9 0,95***	2,4 1,2***	3,0 1,5***	3,5 1,75***
Heating agent working pressure, mPa	0,1	0,1	0,3	0,3	0,3	0,3	0,3
Nominal natural gas pressure, Pa	1300						
Nominal liquefied gas pressure, Pa	1900-2100						
The range of discharge which ensures stable operation of the boiler, Pa	4-25	4-25	4-25	4-25	4-25	4-40	4-40
Smoke temperature °C, not less than	110	110	110	110	110	110	110
Maximum water temperature at boiler exit, °C	90	90	90	90	90	90	90
Hot water supply loop output over 25 °C delta, L/min	-	-	-/4****	-/5****	-/6****	-/7****	-/8****
Chimney connection diameter, mm	100	100	130	130	130	130	130
Gas connection diameter, inch	½"	½"	½"	½"	½"	½"	¾"
Connection diameter of heating, inch	1 ½"	1 ½"	2"	2"	2"	2"	2"
Dimensions, mm: - height - width - depth	748 330 499	748 330 499	744 416 491	744 416 491	961 470 556	961 470 556	961 470 556
Mass not more than, kg - net - gross	37 39	37 39	51/53 53/55	51/53 53/55	71/74 73/76	75/79 77/81	75/79 77/81

1 Pa = 0,102 mm of water column

\* - the result was obtained in laboratory conditions

\*\* - the maximum area of the heated room is determined in the project for the heating system, taking into account all heat losses of the building

\*\*\* - the result was obtained by calculation in the laboratory

\*\*\*\* - when the heating system is switched off, the maximum boiler power, the inlet water temperature is not less than 15 °C, as well as the coolant temperature is not less than 85 °C

# SCHEMATIC DIAGRAM OF THE BOILER

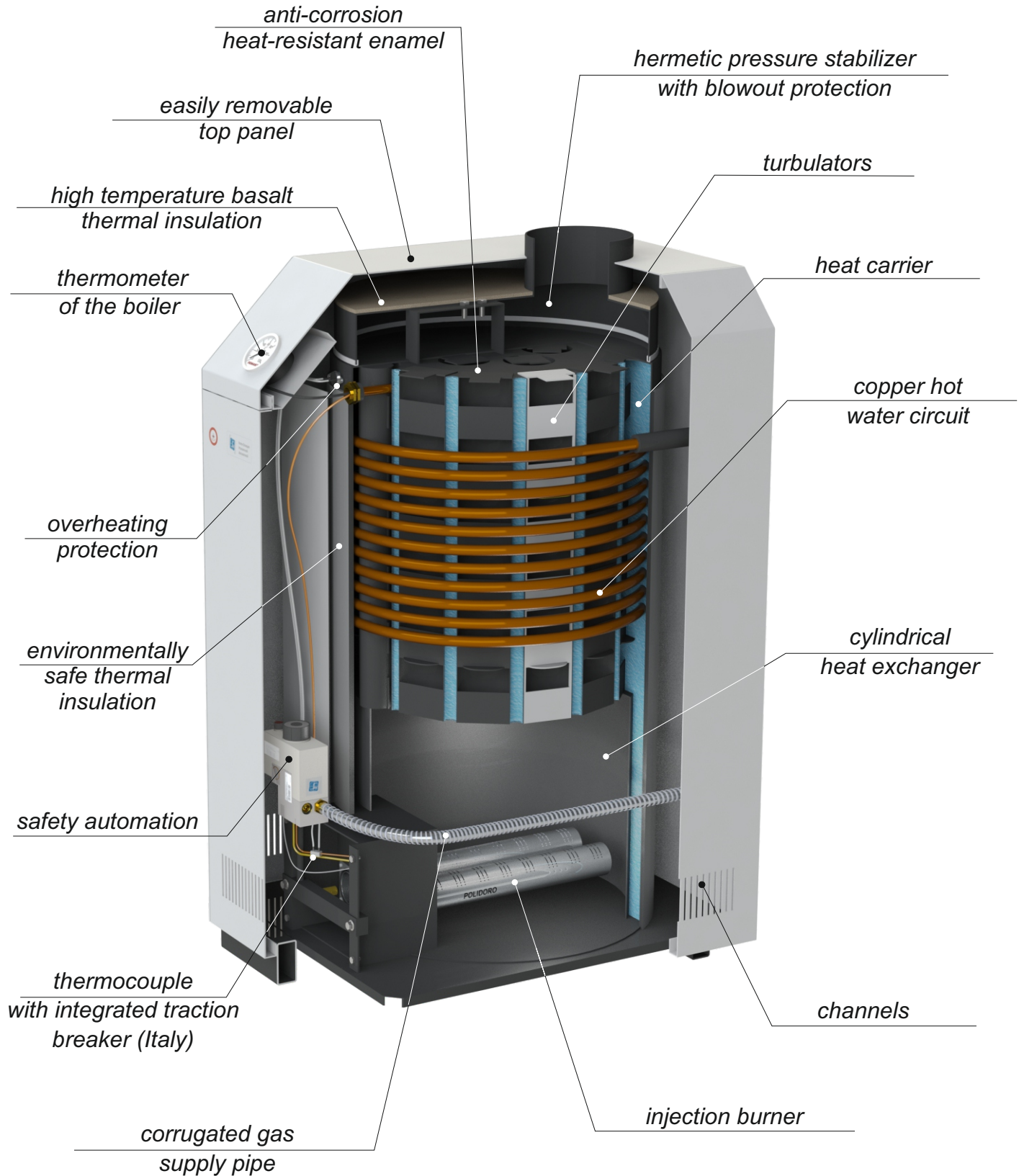



# STEEL GAS BOILERS OF THE PREMIUM N SERIES WITH SAFETY AUTOMATION 820 NOVA

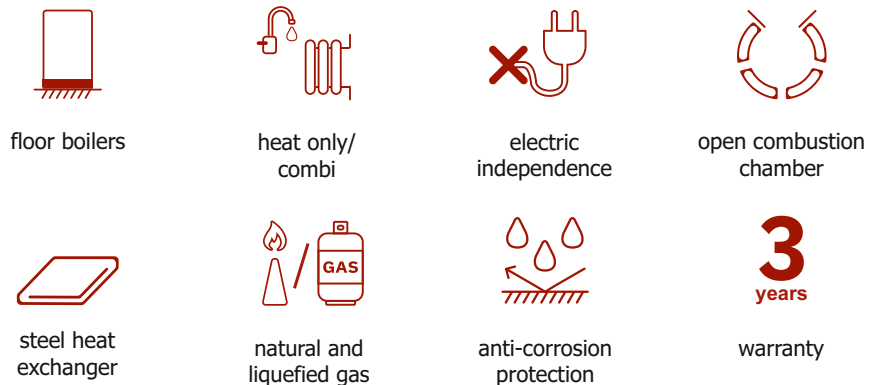
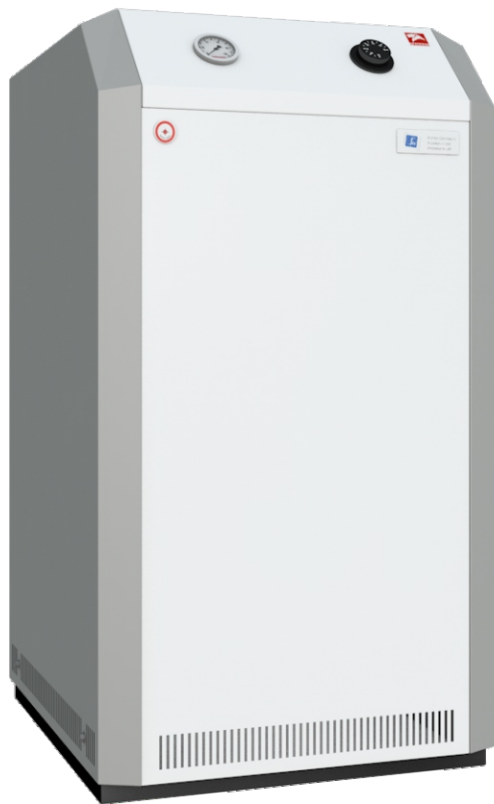

- The model range is from 7,5 to 40 kW.
- Maximum efficiency due to an increase in the heat exchange area and the use of an innovative design of turbulators for maximum delay of exhaust gases.
- Operating pressure:  
from 12,5 to 40 kW - up to 3 atm, from 7,5 to 10 kW - up to 1 atm.
- Improved safety systems against overheating of the heat exchanger, interruption of traction, soot formation, boilerblowing.
- Ease of maintenance of the boiler due to the use of an easily removable top panel.

## SAFETY AUTOMATION 820 NOVA

- The temperature regulator is located on the front panel of the boiler.
- Working in conjunction with monitoring and control device for remote monitoring and control of the gas boiler and heating system indicators through a mobile application.
- Possibility of connecting a room thermostat to regulate the indoor temperature with high precision.
- Work in conjunction with the External Fan of the Comfort SE series for forced exhaust gas removal in the absence of a stationary chimney.
- A soft start system that provides acoustic comfort at the time of boiler start-up.

# STEEL GAS BOILERS OF THE PREMIUM N SERIES WITH SAFETY AUTOMATION 820 NOVA



Parameter	Premium-7,5N	Premium-10N	Premium-12,5N/ Premium-12,5N(W)	Premium-16N/ Premium-16N(W)	Premium-20N/ Premium-20N(W)	Premium-25N/ Premium-25N(W)	Premium-30N/ Premium-30N(W)	Premium-30N/ Premium-30N(W)	Premium-40N/ Premium-40N(W)
Type of gas burner unit	GGU-9N	GGU-12N	GGU-15N	GGU-19N	GGU-24N	GGU-30N	GGU-35N	GGU-40	GGU-50
Gas valve	820 NOVA	820 NOVA	820 NOVA	820 NOVA	820 NOVA	820 NOVA	820 NOVA	820 NOVA	820 NOVA
Nominal heating capacity, kW	7,5	10	12,5	16	20	25	30	35	40
Efficiency, % not less than	90*	90*	90*	90*	90*	90*	90*	90*	90*
Approximate area of the heated room, m <sup>2</sup>	75**	100**	125**	160**	200**	250**	300**	350**	400**
Heat exchanger volume, L	16,5	16,5	24,5	24,5	43	41	41	62,5	62,5
Natural gas consumption, m <sup>3</sup> /h									
- maximum	0,9	1,2	1,5	1,9	2,4	3,0	3,5	4,0	4,5
- average	0,45***	0,6***	0,75***	0,95***	1,2***	1,5***	1,75***	2,0***	2,25***
Heating agent working pressure, mPa	0,1	0,1	0,3	0,3	0,3	0,3	0,3	0,3	0,3
Nominal natural gas pressure, Pa	1300								
Nominal liquefied gas pressure, Pa	1900-2100								
The range of discharge which ensures stable operation of the boiler, Pa	4-25	4-25	4-25	4-25	4-25	4-40	4-40	4-40	4-40
Smoke temperature °C, not less than	110	110	110	110	110	110	110	110	110
Maximum water temperature at boiler exit , °C	90	90	90	90	90	90	90	90	90
Hot water supply loop output over 25 °C delta, L/min	-	-	-/4***	-/5***	-/6***	-/7***	-/8***	-/9***	-/10***
Chimney connection diameter, mm	100	100	130	130	130	130	140	140	140
Gas connection diameter, inch	½"	½"	½"	½"	½"	½"	¾"	¾"	¾"
Connection diameter of heating, inch	1 ½"	1 ½"	2"	2"	2"	2"	2"	2"	2"
Dimensions, mm:									
- height	748	748	744	744	961	961	961	1016	1016
- width	330	330	416	416	470	470	470	532	532
- depth	499	499	491	491	556	556	556	608	608
Mass not more than, kg									
- net	37	37	51/53	51/53	71/74	75/79	75/79	97/101	97/101
- gross	39	39	53/55	53/55	73/76	77/81	77/81	105/109	105/109

1 Pa = 0,102 mm of water column

\* - the result was obtained in laboratory conditions

\*\* - the maximum area of the heated room is determined in the project for the heating system, taking into account all heat losses of the building

\*\*\* - the result was obtained by calculation in the laboratory

\*\*\*\* - when the heating system is switched off, the maximum boiler power, the inlet water temperature is not less than 15 °C, as well as the coolant temperature is not less than 85 °C



# STEEL GAS BOILERS OF THE PREMIUM N SERIES MODELS 50, 60 kW

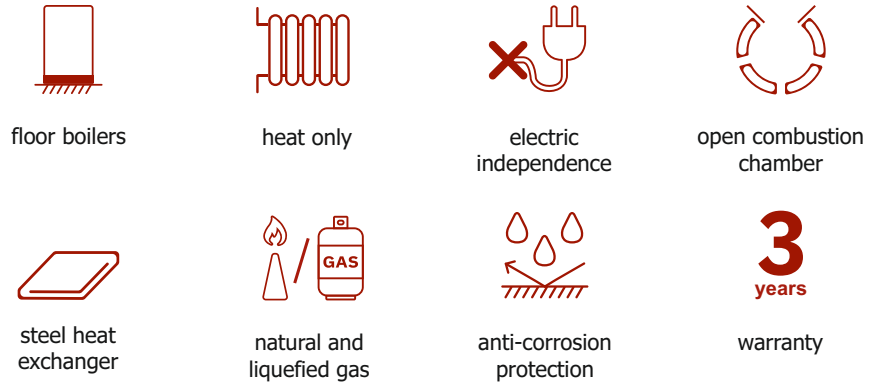
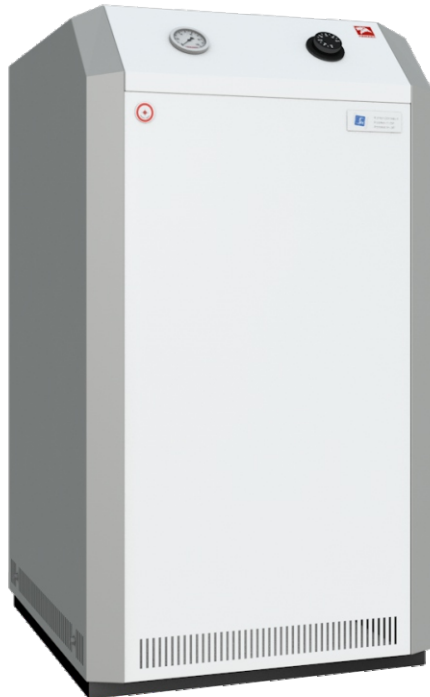

- The model range is from 50 to 60 kW.
- Maximum efficiency due to an increase in the heat exchange area and the use of an innovative design of turbulators for maximum delay of exhaust gases.
- Operating pressure - up to 3 atm.
- Improved safety systems against overheating of the heat exchanger, interruption of traction, soot formation, boilerblowing.
- Ease of maintenance of the boiler due to the use of an easily removable top panel.

## SAFETY AUTOMATION 820 NOVA

- The temperature regulator is located on the front panel of the boiler.
- Working in conjunction with the Lemax monitoring and control device for remote monitoring and control of the gas boiler and heating system indicators through a mobile application.
- Possibility of connecting a room thermostat to regulate the indoor temperature with high precision.
- Work in conjunction with the Lemax External Fan of the Comfort SE series models XL, XXL for forced exhaust gas removal in the absence of a stationary chimney.
- A soft start system that provides acoustic comfort at the time of boiler start-up.

# STEEL GAS BOILERS OF THE PREMIUM N SERIES MODELS 50, 60 kW



Parameter	Premium-50	Premium-60
Type of gas burner unit	GGU-55	GGU-65
Gas valve	820 NOVA	820 NOVA
Nominal heating capacity, kW	50	60
Efficiency, % not less than	90*	90*
Approximate area of the heated room, m <sup>2</sup>	500**	600**
Heat exchanger volume, L	63	63
Natural gas consumption, m <sup>3</sup> /h		
- maximum	5,5	6,5
- average	2,75***	3,25***
Heating agent working pressure, mPa	0,3	0,3
Nominal natural gas pressure, Pa	1300	
Nominal liquefied gas pressure, Pa	1900-2100	
The range of discharge which ensures stable operation of the boiler, Pa	4-40	4-40
Smoke temperature °C, not less than	110	110
Maximum water temperature at boiler exit , °C	90	90
Chimney connection diameter, mm	200	200
Gas connection diameter, inch	¾"	¾"
Connection diameter of heating, inch	2"	2"
Dimensions, mm:		
- height	1102	1102
- width	581	581
- depth	654	654
Mass not more than, kg		
- net	115	115
- gross	122	122

1 Pa = 0,102 mm of water column

\* - the result was obtained in laboratory conditions

\*\* - the maximum area of the heated room is determined in the project for the heating system, taking into account all heat losses of the building

\*\*\* - the result was obtained by calculation in the laboratory

# STEEL GAS BOILERS OF THE PREMIUM N SERIES MODELS 70-100 kW

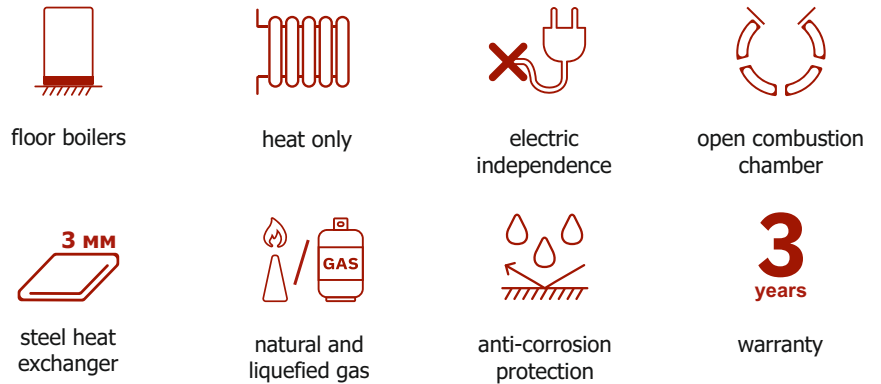

- The model range is from 70 to 100 kW.
- Maximum efficiency due to an increase in the heat exchange area and the use of an innovative design of turbulators for maximum delay of exhaust gases.
- Operating pressure - up to 2 atm.
- Two independently operating safety automatics 820 NOVA.
- Improved safety systems against overheating of the heat exchanger, interruption of traction, soot formation, boilerblowing.
- An overpressure valve is installed in the heating circuit for 3 atm, which allows to compensate for errors during the installation of the heating system.
- Ease of maintenance of the boiler due to the use of an easily removable top panel.

## SAFETY AUTOMATION 820 NOVA

- The temperature regulator is located on the front panel of the boiler.
- Working in conjunction with the Lemax monitoring and control device for remote monitoring and control of the gas boiler and heating system indicators through a mobile application.
- Possibility of connecting a room thermostat to regulate the indoor temperature with high precision.
- A soft start system that provides acoustic comfort at the time of boiler start-up.

# STEEL GAS BOILERS OF THE PREMIUM N SERIES MODELS 70-100 kW

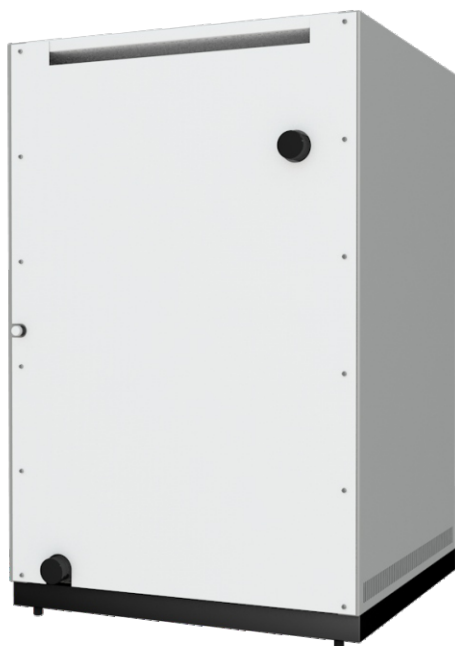

**Premium 70-80 kW**



**Premium 90-100 kW**

Parameter	Premium-70	Premium-80	Premium-90	Premium-100
Type of gas burner unit	GGU-80	GGU-90	GGU-100	GGU-115
Gas valve	820 NOVA	820 NOVA	820 NOVA	820 NOVA
Nominal heating capacity, kW	70	80	90	98
Efficiency, % not less than	90*	90*	90*	90*
Approximate area of the heated room, m <sup>2</sup>	700**	800**	900**	980**
Heat exchanger volume, L	100	100	118	118
Natural gas consumption, m <sup>3</sup> /h				
- maximum	8,0	9,0	10,0	11,5
- average	4,0***	4,5***	5,0***	5,75***
Heating agent working pressure, mPa	0,2	0,2	0,2	0,2
Nominal natural gas pressure, Pa	1300			
Nominal liquefied gas pressure, Pa	1900-2100			
The range of discharge which ensures stable operation of the boiler, Pa	4-40	4-40	4-40	4-40
Smoke temperature °C, not less than	110	110	110	110
Maximum water temperature at boiler exit , °C	90	90	90	90
Chimney connection diameter, mm	200	200	200	200
Gas connection diameter, inch	¾"	¾"	¾"	¾"
Connection diameter of heating, inch	2"	2"	2"	2"
Dimensions, mm:				
- height	1180	1180	1180	1180
- width	754	754	975	975
- depth	753	753	734	734
Mass not more than, kg				
- net	210	210	257	257
- gross	226	226	275	275

1 Pa = 0,102 mm of water column

\* - the result was obtained in laboratory conditions

\*\* - the maximum area of the heated room is determined in the project for the heating system, taking into account all heat losses of the building

\*\*\* - the result was obtained by calculation in the laboratory

# STEEL GAS BOILERS OF THE PERFECT SERIES



floor boilers

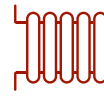

heat only



electric  
independence



open combustion  
chamber



steel heat  
exchanger



natural and  
liquefied gas



anti-corrosion  
protection

**3**  
years

warranty



- The model range is from 7,5 to 40 kW.
- Maximum efficiency due to an increase in the heat exchange area and the use of an innovative design of turbulators for maximum delay of exhaust gases.
- Operating pressure:  
from 12,5 to 40 kW - up to 3 atm, from 7,5 to 10 kW - up to 1 atm.
- Improved safety systems against overheating of the heat exchanger, interruption of traction, soot formation, boilerblowing.
- Ease of maintenance of the boiler due to the use of an easily removable top panel.

## SAFETY AUTOMATION 820 NOVA

- The temperature regulator is located on the front panel of the boiler.
- Working in conjunction with monitoring and control device for remote monitoring and control of the gas boiler and heating system indicators through a mobile application.
- Possibility of connecting a room thermostat to regulate the indoor temperature with high precision.
- Work in conjunction with the External Fan of the Comfort SE series for forced exhaust gas removal in the absence of a stationary chimney.
- A soft start system that provides acoustic comfort at the time of boiler start-up.

# STEEL GAS BOILERS OF THE PERFECT SERIES MODELS 50, 60 kW

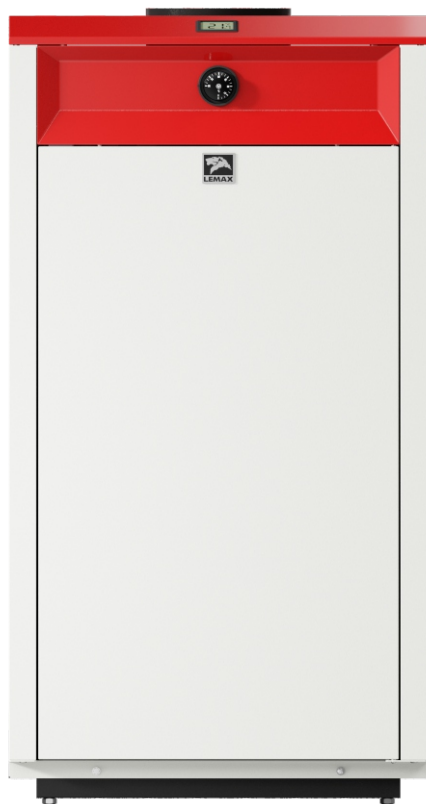

floor boilers

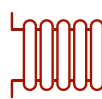

heat only



electric  
independence



open combustion  
chamber



steel heat  
exchanger



natural and  
liquefied gas



anti-corrosion  
protection

**3**  
years

warranty



- The model range is from 50 to 60 kW.
- Maximum efficiency due to an increase in the heat exchange area and the use of an innovative design of turbulators for maximum delay of exhaust gases.
- Operating pressure - up to 3 atm.
- Improved safety systems against overheating of the heat exchanger, interruption of traction, soot formation, boilerblowing.
- Ease of maintenance of the boiler due to the use of an easily removable top panel.

## SAFETY AUTOMATION 820 NOVA

- The temperature regulator is located on the front panel of the boiler.
- Working in conjunction with the Lemax monitoring and control device for remote monitoring and control of the gas boiler and heating system indicators through a mobile application.
- Possibility of connecting a room thermostat to regulate the indoor temperature with high precision.
- Work in conjunction with the Lemax External Fan of the Comfort SE series models XL, XXL for forced exhaust gas removal in the absence of a stationary chimney.
- A soft start system that provides acoustic comfort at the time of boiler start-up.

# STEEL GAS BOILERS OF THE PERFECT SERIES MODELS 70-100 kW

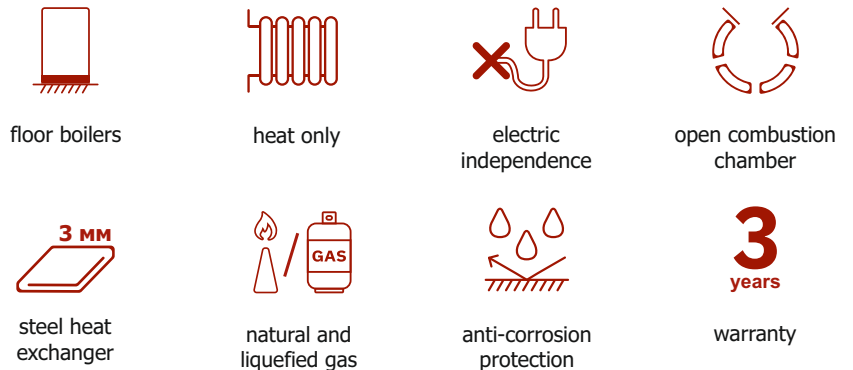

- The model range is from 70 to 100 kW.
- Maximum efficiency due to an increase in the heat exchange area and the use of an innovative design of turbulators for maximum delay of exhaust gases.
- Operating pressure - up to 2 atm.
- Two independently operating safety automatics 820 NOVA.
- Improved safety systems against overheating of the heat exchanger, interruption of traction, soot formation, boilerblowing.
- An overpressure valve is installed in the heating circuit for 3 atm, which allows to compensate for errors during the installation of the heating system.
- Ease of maintenance of the boiler due to the use of an easily removable top panel.

## SAFETY AUTOMATION 820 NOVA

- The temperature regulator is located on the front panel of the boiler.
- Working in conjunction with the Lemax monitoring and control device for remote monitoring and control of the gas boiler and heating system indicators through a mobile application.
- Possibility of connecting a room thermostat to regulate the indoor temperature with high precision.
- A soft start system that provides acoustic comfort at the time of boiler start-up.



# STEEL GAS BOILERS OF THE PERFECT SERIES MODELS 70-100 kW

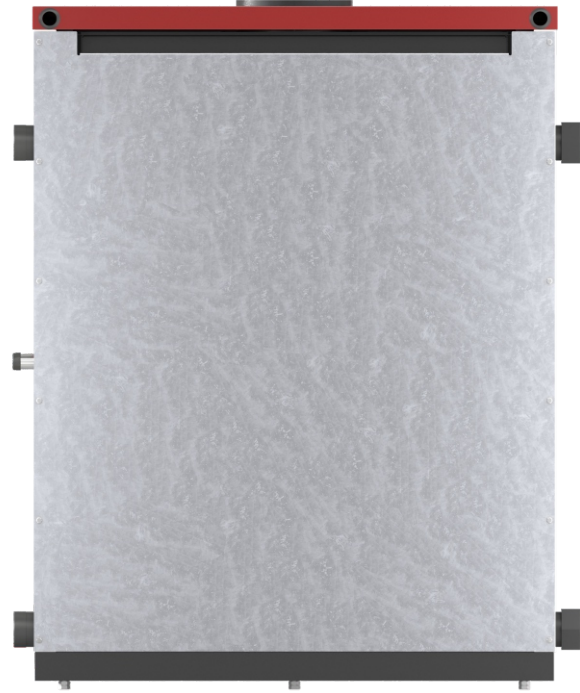

## SAFETY AUTOMATION 820 NOVA

- The temperature regulator is located on the front panel of the boiler.
- Working in conjunction with the Lemax monitoring and control device for remote monitoring and control of the gas boiler and heating system indicators through a mobile application.
- Possibility of connecting a room thermostat to regulate the indoor temperature with high precision.
- A soft start system that provides acoustic comfort at the time of boiler start-up.



# STEEL GAS BOILERS OF THE CLASSIC SERIES



floor boilers



heat only/  
combi



electric  
independence



open combustion  
chamber



steel heat  
exchanger



natural and  
liquefied gas



anti-corrosion  
protection

**3**  
years

warranty

- The model range is from 7,5 to 40 kW.
- Boilers of the Classic series are suitable for replacing Lemax boilers of the KSG-d series without changing the connecting dimensions of the heating system.
- Maximum efficiency due to an increase in the heat exchange area and the use of an innovative design of turbulators for maximum delay of exhaust gases.
- Operating pressure:  
from 12,5 to 40 kW - up to 3 atm, from 7,5 to 10 kW - up to 1 atm.
- Improved safety systems against overheating of the heat exchanger, interruption of traction, soot formation, boilerblowing.
- Affordable price with the preservation of efficiency parameters due to the unification of equipment elements, standardization of components and robotization of production processes.
- Ease of maintenance of the boiler due to the use of an easily removable top panel.

Parameter	Classic-7,5	Classic-10	Classic-12,5/ Classic-12,5W	Classic-16/ Classic-16W	Classic-20/ Classic-20W	Classic-25/ Classic-25W	Classic-30/ Classic-30W	Classic-35/ Classic-35W	Classic-40/ Classic-40W
Type of gas burner unit	GGU-9d	GGU-12d	GGU-15d	GGU-19d	GGU-25d	GGU-30d	GGU-35d	GGU-40d	GGU-45d
Gas valve	630 EUROSIT	630 EUROSIT	630 EUROSIT	630 EUROSIT	630 EUROSIT	710 EUROSIT	710 EUROSIT	820 NOVA	820 NOVA
Nominal heating capacity, kW	7,5	10	12,5	16	20	25	30	35	40
Efficiency, % not less than	88*	88*	90*	90*	90*	90*	90*	90*	90*
Approximate area of the heated room, m <sup>2</sup>	75**	100**	125**	160**	200**	250**	300**	350**	400**
Heat exchanger volume, L	16,5	16,5	24	24	45	43	43	62,5	62,5
Natural gas consumption, m <sup>3</sup> /h									
- maximum	0,9	1,2	1,5	1,9	2,4	3,0	3,5	4,0	4,5
- average	0,45***	0,6***	0,75***	0,95***	1,2***	1,5***	1,75***	2,0***	2,25***
Heating agent working pressure, mPa	0,1	0,1	0,3	0,3	0,3	0,3	0,3	0,3	0,3
Nominal natural gas pressure, Pa	1300								
Nominal liquefied gas pressure, Pa	1900-2100								
The range of discharge which ensures stable operation of the boiler, Pa	3-25	3-25	3-25	3-25	3-25	3-40	3-40	3-40	3-40
Smoke temperature °C, not less than	110	110	110	110	110	110	110	110	110
Maximum water temperature at boiler exit, °C	90	90	90	90	90	90	90	90	90
Chimney connection diameter, mm	100	100	130	130	130	130	130	140	140
Hot water supply loop output over 25 °C delta, L/min	-	-	-/4****	-/5****	-/6****	-/7****	-/8****	-/9****	-/10****
Gas connection diameter, inch	½"	½"	½"	½"	½"	½"	½"	½"	½"
Connection diameter of heating, inch	1 ½"	1 ½"	2"	2"	2"	2"	2"	2"	2"
Dimensions, mm:									
- height	677	677	744	744	926	926	926	1021	1021
- width	282	282	410	410	451	451	451	530	530
- depth	474	474	505	505	568	568	568	622	622
Mass not more than, kg									
- net	31	31	46/48	46/48	67/70	71/74	71/74	97/101	97/101
- gross	33	33	48/50	48/50	69/73	73/76	73/76	105/109	105/109

1 Pa = 0,102 mm of water column

\* - the result was obtained in laboratory conditions

\*\* - the maximum area of the heated room is determined in the project for the heating system, taking into account all heat losses of the building

\*\*\* - the result was obtained by calculation in the laboratory

\*\*\*\* - when the heating system is switched off, the maximum boiler power, the inlet water temperature is not less than 15 °C, as well as the coolant temperature is not less than 85 °C

# STEEL GAS BOILERS OF THE CLASSIC N SERIES MODELS 35, 40 kW

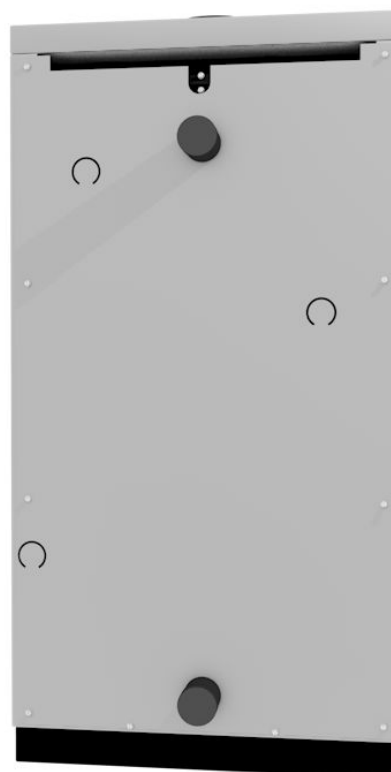

## SAFETY AUTOMATION 820 NOVA

- The temperature regulator is located on the front panel of the boiler.
- Working in conjunction with monitoring and control device for remote monitoring and control of the gas boiler and heating system indicators through a mobile application.
- Possibility of connecting a room thermostat to regulate the indoor temperature with high precision.
- Work in conjunction with the Lemax External Fan of the Comfort SE series for forced exhaust gas removal in the absence of a stationary chimney.
- A soft start system that provides acoustic comfort at the time of boiler start-up.

# STEEL GAS BOILERS OF THE CLASSIC SERIES MODELS 50, 60 kW

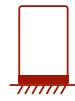

floor boilers

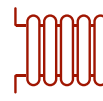

heat only



electric independence



open combustion chamber



steel heat exchanger



natural and liquefied gas



anti-corrosion protection

**3**  
years

warranty



- The model range is from 50 to 60 kW.
- Maximum efficiency due to an increase in the heat exchange area and the use of an innovative design of turbulators for maximum delay of exhaust gases.
- Operating pressure - up to 3 atm.
- Improved safety systems against overheating of the heat exchanger, interruption of traction, soot formation, boilerblowing.
- Ease of maintenance of the boiler due to the use of an easily removable top panel.

## SAFETY AUTOMATION 820 NOVA

- The temperature regulator is located on the front panel of the boiler.
- Working in conjunction with the Lemax monitoring and control device for remote monitoring and control of the gas boiler and heating system indicators through a mobile application.
- Possibility of connecting a room thermostat to regulate the indoor temperature with high precision.
- Work in conjunction with the Lemax External Fan of the Comfort SE series models XL, XXL for forced exhaust gas removal in the absence of a stationary chimney.
- A soft start system that provides acoustic comfort at the time of boiler start-up.

# STEEL GAS BOILERS OF THE CLASSIC SERIES MODELS 50, 60 kW



Parameter	Classic-50	Classic-60
Type of gas burner unit	GGU-55	GGU-65
Gas valve	820 NOVA	820 NOVA
Nominal heating capacity, kW	50	60
Efficiency, % not less than	90*	90*
Approximate area of the heated room, m <sup>2</sup>	500**	600**
Heat exchanger volume, L	63	63
Natural gas consumption, m <sup>3</sup> /h - maximum - average	5,5 2,75***	6,5 3,25***
Heating agent working pressure, mPa	0,3	0,3
Nominal natural gas pressure, Pa	1300	
Nominal liquefied gas pressure, Pa	1900-2100	
The range of discharge which ensures stable operation of the boiler, Pa	4-40	4-40
Smoke temperature °C, not less than	110	110
Maximum water temperature at boiler exit , °C	90	90
Chimney connection diameter, mm	200	200
Gas connection diameter, inch	¾"	¾"
Connection diameter of heating, inch	2"	2"
Dimensions, mm: - height - width - depth	1102 581 654	1102 581 654
Mass not more than, kg - net - gross	115 122	115 122

1 Pa = 0,102 mm of water column

\* - the result was obtained in laboratory conditions

\*\* - the maximum area of the heated room is determined in the project for the heating system, taking into account all heat losses of the building

\*\*\* - the result was obtained by calculation in the laboratory

# STEEL GAS BOILERS OF THE CLASSIC SERIES MODELS 70-100 kW

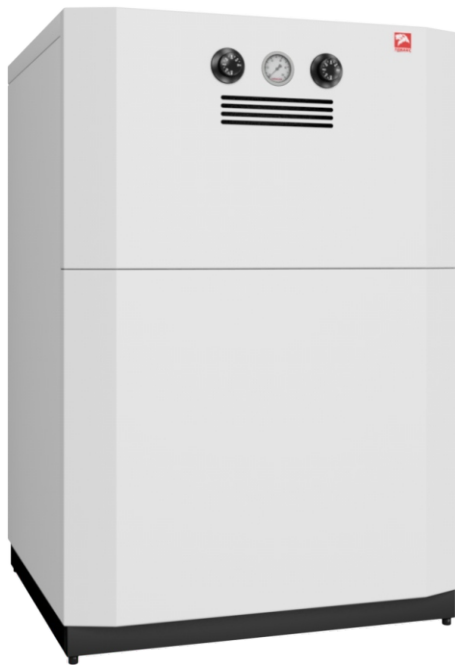

floor boilers

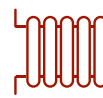

heat only



electric  
independence



open combustion  
chamber



steel heat  
exchanger



natural and  
liquefied gas



anti-corrosion  
protection



warranty

- The model range is from 70 to 100 kW.
- Maximum efficiency due to an increase in the heat exchange area and the use of an innovative design of turbulators for maximum delay of exhaust gases.
- Operating pressure - up to 2 atm.
- Two independently operating safety automatics 820 NOVA.
- Improved safety systems against overheating of the heat exchanger, interruption of traction, soot formation, boilerblowing.
- An overpressure valve is installed in the heating circuit for 3 atm, which allows to compensate for errors during the installation of the heating system.
- Ease of maintenance of the boiler due to the use of an easily removable top panel.

## SAFETY AUTOMATION 820 NOVA

- The temperature regulator is located on the front panel of the boiler.
- Working in conjunction with the Lemax monitoring and control device for remote monitoring and control of the gas boiler and heating system indicators through a mobile application.
- Possibility of connecting a room thermostat to regulate the indoor temperature with high precision.
- A soft start system that provides acoustic comfort at the time of boiler start-up.

# STEEL GAS BOILERS OF THE CLASSIC SERIES MODELS 70-100 kW



**Classic 70-80 kW**

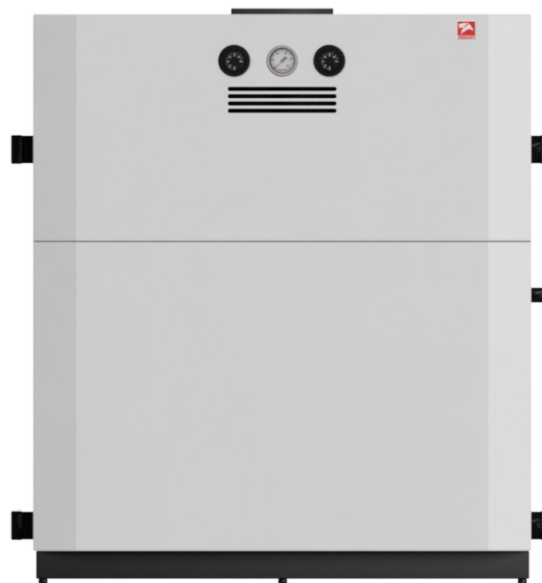

**Classic 90-100 kW**

Parameter	Classic-70	Classic-80	Classic-90	Classic-100
Type of gas burner unit	GGU-80	GGU-90	GGU-100	GGU-115
Gas valve	820 NOVA	820 NOVA	820 NOVA	820 NOVA
Nominal heating capacity, kW	70	80	90	98
Efficiency, % not less than	90*	90*	90*	90*
Approximate area of the heated room, m <sup>2</sup>	700**	800**	900**	980**
Heat exchanger volume, L	100	100	118	118
Natural gas consumption, m <sup>3</sup> /h				
- maximum	8,0	9,0	10,0	11,5
- average	4,0***	4,5***	5,0***	5,75***
Heating agent working pressure, mPa	0,2	0,2	0,2	0,2
Nominal natural gas pressure, Pa	1300			
Nominal liquefied gas pressure, Pa	1900-2100			
The range of discharge which ensures stable operation of the boiler, Pa	4-40	4-40	4-40	4-40
Smoke temperature °C, not less than	110	110	110	110
Maximum water temperature at boiler exit, °C	90	90	90	90
Chimney connection diameter, mm	200	200	200	200
Gas connection diameter, inch	¾"	¾"	¾"	¾"
Connection diameter of heating, inch	2"	2"	2"	2"
Dimensions, mm:				
- height	1180	1180	1180	1180
- width	754	754	975	975
- depth	753	753	734	734
Mass not more than, kg				
- net	210	210	257	257
- gross	226	226	275	275

1 Pa = 0,102 mm of water column

\* - the result was obtained in laboratory conditions

\*\* - the maximum area of the heated room is determined in the project for the heating system, taking into account all heat losses of the building

\*\*\* - the result was obtained by calculation in the laboratory



# STEEL GAS BOILERS OF THE PATRIOT SERIES WITH CLOSED COMBUSTION CHAMBER

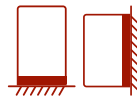

floor or wall mounted boilers

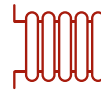

heat only



electric independence

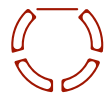

closed combustion chamber



steel heat exchanger



natural gas



anti-corrosion protection

**3**  
года

warranty

- The model range is from 6 to 20 kW.
- Maximum efficiency due to an increase in the heat exchange area and the use of an innovative design of turbulators for maximum delay of exhaust gases.
- Operating pressure - up to 1,5 atm.
- Improved safety systems against overheating of the heat exchanger. Coaxial smoke extraction system that does not require the organization of a stationary chimney(stainless steel configuration is possible).
- Viewing window for monitoring the gorenje of the main and ignition burners.
- Ease of maintenance of the boiler due to the use of an easily removable top panel.

## 2 TYPES OF UNIVERSAL SMOKE REMOVAL SYSTEMS:

- for boilers from 6 to 12,5 kW,
- for boilers from 16 to 20 kW.

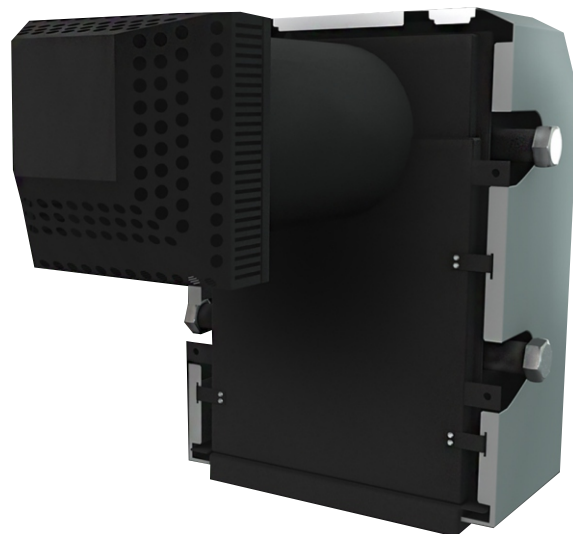

# STEEL GAS BOILERS OF THE PATRIOT SERIES WITH CLOSED COMBUSTION CHAMBER



Parameter	Patriot-6	Patriot-7,5	Patriot-10	Patriot-12,5	Patriot-16	Patriot-20
Type of gas burner unit	GGU-7,5p	GGU-9p	GGU-12p	GGU-15p	GGU-19p	GGU-25p
Gas valve	630 EUROSIT	630 EUROSIT	630 EUROSIT	630 EUROSIT	630 EUROSIT	630 EUROSIT
Nominal heating capacity, kW	6	7,5	10	12,5	16	20
Efficiency, % not less than	87*	87*	87*	87*	87*	87*
Approximate area of the heated room, m <sup>2</sup>	60**	75**	100**	125**	160**	200**
Heat exchanger volume, L	9,8	9,8	14,4	14,4	20,7	20,7
Natural gas consumption, m <sup>3</sup> /h						
- maximum	0,75	0,9	1,2	1,5	1,9	2,4
- average	0,38***	0,45***	0,6***	0,75***	0,95***	1,2***
Heating agent working pressure, mPa	0,15	0,15	0,15	0,15	0,15	0,15
Nominal natural gas pressure, Pa	1300					
Smoke temperature °C, not less than	110	110	110	110	110	110
Maximum water temperature at boiler exit , °C	90	90	90	90	90	90
Chimney connection diameter, mm	250	250	250	250	310	310
Length of the coaxial chimney, mm	330-800	330-800	330-800	330-800	330-800	330-800
Gas connection diameter, inch	½"	½"	½"	½"	½"	½"
Connection diameter of heating, inch	1 ½"	1 ½"	1 ½"	1 ½"	2"	2"
Dimensions, mm:						
- height	740	740	740	740	790	790
- width	550	550	595	595	670	670
- depth	310	310	360	360	400	400
Mass not more than, kg						
- net	43	43	48	48	66	66
- gross	45	45	50	50	68	68

1 Pa = 0,102 mm of water column

\* - the result was obtained in laboratory conditions

\*\* - the maximum area of the heated room is determined in the project for the heating system, taking into account all heat losses of the building

\*\*\* - the result was obtained by calculation in the laboratory

# STEEL GAS BOILERS OF THE CLEVER SERIES

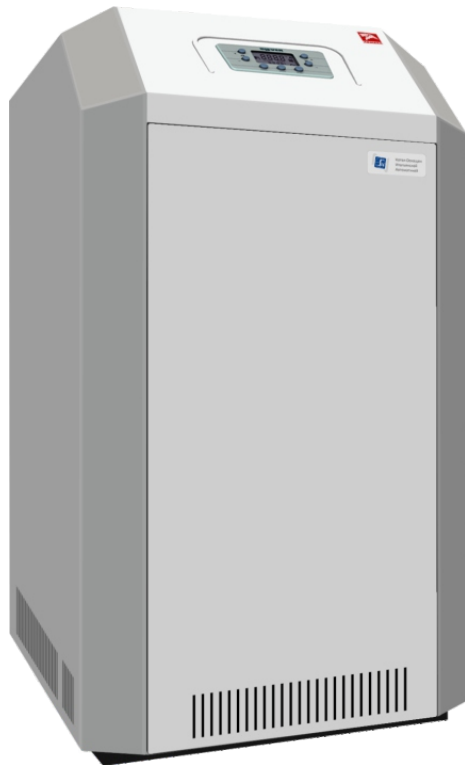

floor boilers

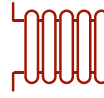

heat only

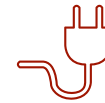

electric  
dependence



open combustion  
chamber



steel heat  
exchanger



natural gas



anti-corrosion  
protection



warranty



## SAFETY AUTOMATION 845 SIGMA

- The model range is from 20 to 55 kW.
- Operating pressure up to 3 atm.
- Improved safety systems against overheating of the heat exchanger, interruption of traction, soot formation, freezing of the boiler.
- Work in a heating system with forced and natural circulation of the coolant.
- Efficient operation with a minimum ratio of the volume of water in the boiler to the weight and area of the heat exchanger.
- Continuous smooth power modulation that minimizes energy consumption.
- The possibility of connecting:  
an indirect heating tank, a thermostat with which you can adjust the boiler temperature relative to the indoor temperature, monitoring and control device for monitoring and controlling comfort in the house (Android and iOS), outdoor temperature sensors, External Fan of the Lemax Comfort series for forced exhaust gas removal, heating and hot water pumps.
- It is resistant to voltage drops (180 - 245 V) and gas pressure (6 - 25 mbar).
- Low noise level.
- Ease of maintenance of the boiler due to the use of an easily removable top panel.

# STEEL GAS BOILERS OF THE CLEVER SERIES

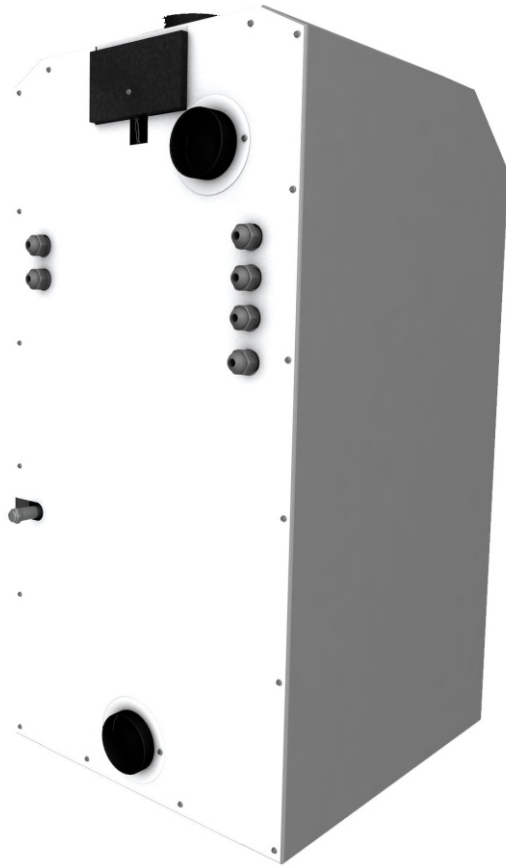
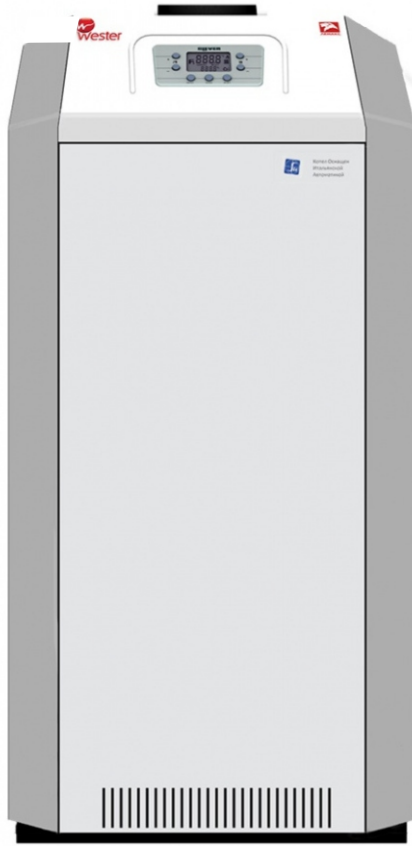

Parameter	CLEVER-20	CLEVER-30	CLEVER-40	CLEVER-55
Gas valve	845 SIGMA	845 SIGMA	845 SIGMA	845 SIGMA
Nominal heating capacity, kW	20	30	40	55
Efficiency, % not less than	90*	90*	90*	90*
Approximate area of the heated room, m <sup>2</sup>	200**	300**	400**	550**
Heat exchanger volume, L	43	41	62,5	63
Natural gas consumption, m <sup>3</sup> /h				
- maximum	2,4	3,5	4,5	6,2
- average	1,25***	1,75***	2,25***	3,1***
Heating agent working pressure, mPa	0,2	0,2	0,2	0,2
Nominal natural gas pressure, Pa	1300			
Nominal liquefied gas pressure, Pa	1900-2100			
The range of discharge which ensures stable operation of the boiler, Pa	4-25	4-40	4-40	4-40
Smoke temperature °C, not less than	110	110	110	110
Maximum water temperature at boiler exit, °C	90	90	90	90
Chimney connection diameter, mm	130	130	140	200
Gas connection diameter, inch	¾"	¾"	¾"	¾"
Connection diameter of heating, inch	2"	2"	2"	2"
Power supply voltage, V	220	220	220	220
Supply network frequency, Hz	50	50	50	50
Electrical power (without additional accessories), W	15	15	15	15
Dimensions, mm:				
- height	961	961	1016	1102
- width	470	470	532	581
- depth	556	556	608	656
Mass not more than, kg				
- net	77	79	97	117
- gross	84	86	106	127

1 Pa = 0,102 mm of water column

\* - the result was obtained in laboratory conditions

\*\* - the maximum area of the heated room is determined in the project for the heating system, taking into account all heat losses of the building

\*\*\* - the result was obtained by calculation in the laboratory

# STEEL GAS HEATING FACILITY SERIES PREMIER



floor boilers

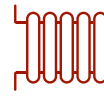

heat only



electric  
independence



open combustion  
chamber



steel heat  
exchanger



natural gas



anti-corrosion  
protection

**3**  
years

warranty

## SAFETY AUTOMATION 820 NOVA



- The model range is from 11,6 to 35 kW.
- Maximum efficiency due to an increase in the heat exchange area and the use of an innovative design of turbulators for maximum delay of exhaust gases.
- Operating pressure: from 17,4 to 35 kW - up to 3 atm., 11,6 kW - up to 1 atm.
- The presence of the safety systems against interruption of traction, soot formation, blowing out of the heating apparatus.
- The temperature controller with a scale is placed on the front panel of the device for convenience.
- Work together with monitoring and control device for remote monitoring and control of gas boilers and heating system indicators, via a mobile application.
- Possibility of connecting a room thermostat to adjust the temperature inside the room.
- Working together with the Lemax External Fan of the Comfort SE series for forced exhaust gas discharge in the absence of a stationary chimney.
- A smooth start system that provides acoustic comfort at the time of the device's start.

# STEEL GAS HEATING FACILITY SERIES PREMIER



- Possibility of connecting a vertical or horizontal chimney.

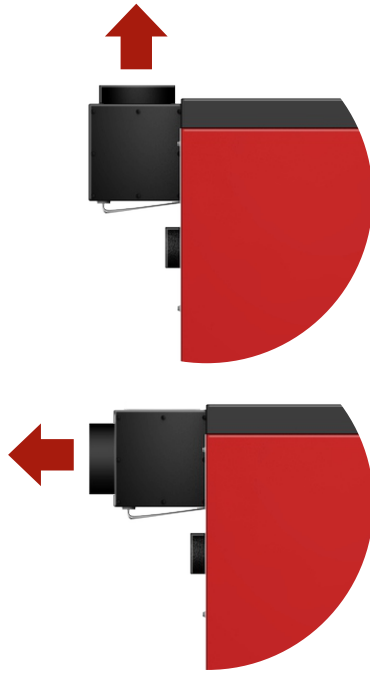

- Convenience of cleaning the boiler without disconnecting from the chimney due to the use of removable lining covers and a weight stabilizer.



Parameter	Premier-6	Premier-8	Premier-11,6	Premier-15	Premier-17,4	Premier-23,2	Premier-29	Premier-35
Gas valve	820 NOVA	820 NOVA	820 NOVA	820 NOVA	820 NOVA	820 NOVA	820 NOVA	820 NOVA
Nominal heating capacity, kW	6	8	11,6	15	17,4	23,2	29	35
Efficiency, % not less than	90*	90*	90*	90*	90*	90*	90*	90*
Approximate area of the heated room, m <sup>2</sup>	50**	70**	100**	125**	160**	200**	250**	300**
Heat exchanger volume, L	16,5	16,5	16,5	24,5	24,5	43	41	41
Natural gas consumption, m <sup>3</sup> /h								
- maximum	0,6	0,8	1,16	1,5	1,74	2,32	2,9	3,5
- average	0,3***	0,4***	0,6***	0,75***	0,9***	1,2***	1,5***	1,75***
Heating agent working pressure, mPa	0,1	0,1	0,1	0,3	0,3	0,3	0,3	0,3
Nominal natural gas pressure, Pa	1300							
The range of discharge which ensures stable operation of the boiler, Pa	3-29	3-29	3-29	3-29	3-29	3-29	3-29	3-29
Smoke temperature °C, not less than	110	110	110	110	110	110	110	110
Maximum water temperature at boiler exit , °C	90	90	90	90	90	90	90	90
Chimney connection diameter, mm	120	120	120	130	130	140	140	140
Gas connection diameter, inch	½"	½"	½"	¾"	¾"	¾"	¾"	¾"
Connection diameter of heating, inch	1 ½"	1 ½"	1 ½"	2"	2"	2"	2"	2"
Dimensions, mm:								
- height	835	835	835	865	865	1065	1065	1065
- width	324	324	324	412	412	465	465	465
- depth	570	570	570	612	612	690	690	690
Mass not more than, kg								
- net	42	42	42	60	60	76	79	79
- gross	44	44	44	62	62	86	89	89

1 Pa = 0,102 mm of water column

\* - the result was obtained in laboratory conditions

\*\* - the maximum area of the heated room is determined in the project for the heating system, taking into account all heat losses of the building

\*\*\* - the result was obtained by calculation in the laboratory



# STEEL GAS HEATING FACILITY SERIES PREMIER 55-100 kW



floor boilers

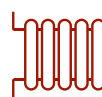

heat only



electric independence



open combustion chamber



steel heat exchanger



natural gas



anti-corrosion protection

**3**  
years

warranty

## SAFETY AUTOMATION 820 NOVA



\* only for Premier-55

- The model range is from 55 to 100 kW.
- Maximum efficiency due to an increase in the heat exchange area and the use of an innovative design of turbulators for maximum delay of exhaust gases.
- Operating pressure: 55 kW - up to 3 atm., from 80 to 100 - up to 2 atm.
- The presence of the safety systems against interruption of traction, soot formation, blowing out of the heating apparatus.
- The temperature controller with a scale is placed on the front panel of the device for convenience.
- Work together with monitoring and control device for remote monitoring and control of gas boilers and heating system indicators, via a mobile application.
- Possibility of connecting a room thermostat to adjust the temperature inside the room.
- Working together with the Lemax External Fan of the Comfort SE series models XL (only for Premier-55) for forced exhaust gas discharge in the absence of a stationary chimney.
- A smooth start system that provides acoustic comfort at the time of the device's start.
- Ease of maintenance of the device due to the use of an easily removable top panel.

# STEEL GAS HEATING FACILITY SERIES PREMIER 55-100 kW



Parameter	Premier - 55	Premier - 80	Premier - 100
Gas valve	820 NOVA	820 NOVA	820 NOVA
Nominal heating capacity, kW	55	80	100
Efficiency, % not less than	90*	90*	90*
Approximate area of the heated room, m <sup>2</sup>	500**	700**	900**
Heat exchanger volume, L	63	100	118
Natural gas consumption, m <sup>3</sup> /h			
- maximum	5,5	8,0	10,0
- average	2,75***	4,0***	5,0***
Heating agent working pressure, mPa	0,3	0,2	0,2
Nominal natural gas pressure, Pa	1300		
The range of discharge which ensures stable operation of the boiler, Pa	4-40	4-40	4-40
Smoke temperature °C, not less than	110	110	110
Maximum water temperature at boiler exit , °C	90	90	90
Chimney connection diameter, mm	200	200	200
Gas connection diameter, inch	¾"	¾"	¾"
Connection diameter of heating, inch	2"	2"	2"
Dimensions, mm:			
- height	1102	1280	1280
- width	581	754	975
- depth	654	753	734
Mass not more than, kg			
- net	122	211	252
- gross	129	228	286

1 Pa = 0,102 mm of water column

\* - the result was obtained in laboratory conditions

\*\* - the maximum area of the heated room is determined in the project for the heating system, taking into account all heat losses of the building

\*\*\* - the result was obtained by calculation in the laboratory

# STEEL GAS HEATING FACILITY SERIES GAZOVIK

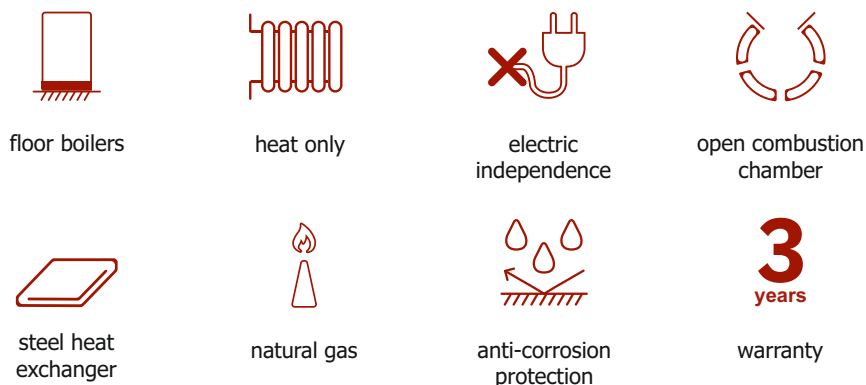

- The model range is from 6 to 29 kW.
- Maximum efficiency due to an increase in the heat exchange area and the use of an innovative design of turbulators for maximum delay of exhaust gases.
- Operating pressure:  
from 15,5 to 29 kW - up to 3 atm., from 6 to 11,6 kW - up to 1 atm.
- The presence of the safety systems against interruption of traction, soot formation, boiler blowing.
- Ease of maintenance of the boiler due to the use of an easily removable top panel.

Parameter	Gazovik-6	Gazovik-8	Gazovik-11,6	Gazovik-13,5	Gazovik-15,5	Gazovik-23,2	Gazovik-29
Gas valve	630 EUROSIT	630 EUROSIT	630 EUROSIT	630 EUROSIT	630 EUROSIT	630 EUROSIT	710 MINISIT
Nominal heating capacity, kW	6	8	11,6	13,5	15,5	23,2	29
Efficiency, % not less than	86*	86*	87*	87*	87*	87*	87*
Approximate area of the heated room, m <sup>2</sup>	50**	70**	100**	120**	135**	200**	250**
Heat exchanger volume, L	16,5	16,5	16,5	24	24	45	43
Natural gas consumption, m <sup>3</sup> /h							
- maximum	0,6	0,8	1,16	1,35	1,55	2,32	2,9
- average	0,3***	0,4***	0,6***	0,7***	0,8***	1,2***	1,5***
Heating agent working pressure, mPa	0,1	0,1	0,1	0,3	0,3	0,3	0,3
Nominal natural gas pressure, Pa	1274	1274	1274	1274	1274	1274	1274
The range of discharge which ensures stable operation of the boiler, Pa	3-29	3-29	3-29	3-29	3-29	3-29	3-29
Smoke temperature °C, not less than	110	110	110	110	110	110	110
Maximum water temperature at boiler exit , °C	90	90	90	90	90	90	90
Chimney connection diameter, mm	120	120	120	130	130	140	140
Gas connection diameter, inch	½"	½"	½"	¾"	¾"	¾"	¾"
Connection diameter of heating, inch	1 ½"	1 ½"	1 ½"	2"	2"	2"	2"
Dimensions, mm:							
- height	685	685	685	750	750	938	938
- width	282	282	282	410	410	451	451
- depth	473	473	473	505	505	568	568
Mass not more than, kg							
- net	31	31	31	46	46	67	67
- gross	33	33	33	48	48	69	69

1 Pa = 0,102 mm of water column

\* - the result was obtained in laboratory conditions

\*\* - the maximum area of the heated room is determined in the project for the heating system, taking into account all heat losses of the building

\*\*\* - the result was obtained by calculation in the laboratory

# STEEL GAS BOILERS OF THE CLEVER L SERIES



floor boilers

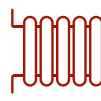

heat only

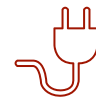

electric  
dependence



open combustion  
chamber

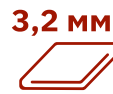

**3,2 MM**

steel heat  
exchanger



natural gas



anti-corrosion  
protection

**2**  
years

warranty



- The model range is 40 kW, 50 kW, 80 kW, 90 kW.
- The working pressure is up to 6 atm.
- Thyristor control with high resource potential.
- Smooth power modulation in a ratio of 1:3, which ensures minimal load on the components of the heating system and minimizes gas consumption.
- Low power consumption.
- Protection against freezing, overheating of the heat exchanger, reverse draft in the chimney, excessive pressure of the coolant in the heating circuit.
- Efficient operation with a minimum ratio of the volume of water in the boiler to the weight and area of the heat exchanger.
- Resistance to voltage fluctuations (180 - 245 V) and gas pressure (6-25 Mbar).
- The possibility of connecting: an indirect heating tank, an outdoor temperature sensor, a boiler circulation pump and an indirect heating tank loading, a thermostat for regulating the temperature of the coolant depending on indoor conditions, a remote control system and comprehensive monitoring of heating system components via Rs485 protocol.
- The convenience of boiler maintenance due to the use of

# STEEL GAS BOILERS OF THE CLEVER L SERIES

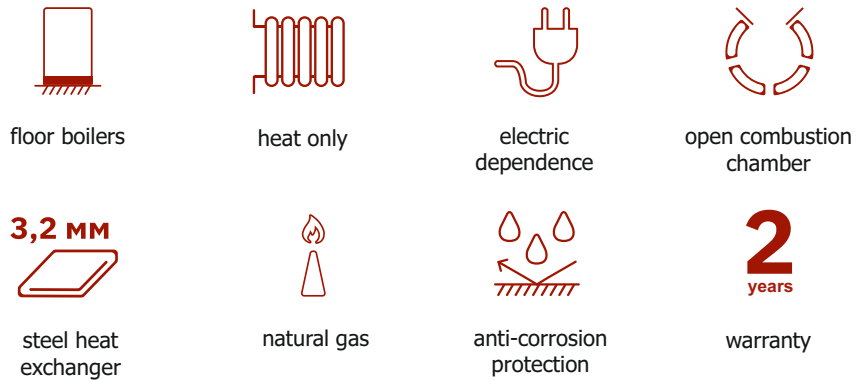
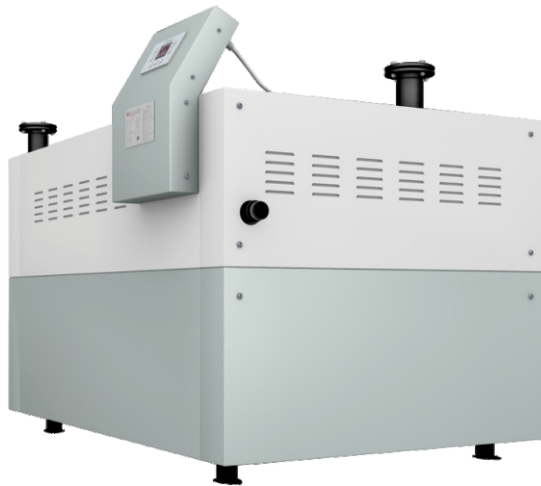

## SAFETY AUTOMATION 845 SIGMA



- The model range is 100 kW, 150 kW, 180 kW, 200 kW.
- Operating pressure up to 6 atm.
- Smooth power modulation in a ratio of 1:3, which ensures minimal load on the components of the heating system and minimizes gas consumption.
- Low power consumption.
- The improved systems of safety against freezing, overheating of the heat exchanger, reverse draft in the chimney, excess pressure of the coolant in the heating circuit.
- Efficient operation with a minimum ratio of the volume of water in the boiler to the weight and area of the heat exchanger.
- Resistance to voltage drops (180 - 245 V) and gas pressure (6-25 Mbar).
- Connectivity:  
tank for indirect heating, sensor outdoor temperature, the circulation pump of the boiler and tank for indirect heating, thermostat for regulating the temperature of the coolant depending on the condition of the premises, the system remote control and comprehensive monitoring of the components of the heating system in Rs485 Protocol, External Fan of Lemax series models Comfort-150 and Comfort-180 (for CLEVER L150 and CLEVER L180).
- Serviceability of the boiler through the use of removable lining.

# STEEL GAS BOILERS OF THE CLEVER L SERIES



**CLEVER L150**



**CLEVER L100, L180, L200**

Parameter	CLEVER L100	CLEVER L150	CLEVER L180	CLEVER L200
Gas valve	845 SIGMA	845 SIGMA	845 SIGMA	845 SIGMA
Nominal heating capacity in heating mode of 80/60, kW	100	150	180	200
Minimum heat output in heating mode of 80/60, kW	30	50	60	70
Efficiency, % not less than	92*	92*	92*	92*
Heat exchanger volume, L	14	22	22	22
Natural gas consumption, m <sup>3</sup> /h				
- maximum	11,6	17,5	20,5	23,2
- average	5,8**	8,8**	10,3**	11,6**
Heating agent working pressure, mPa	0,15-0,6	0,15-0,6	0,15-0,6	0,15-0,6
Nominal natural gas pressure, Pa	1700-2500	1700-2500	1700-2500	1700-2500
The range of discharge which ensures stable operation of the boiler, Pa	20-40	20-40	20-40	20-40
Smoke temperature with maximum heat output, °C	80	90	85	90
Smoke temperature with minimum heat output, °C	120	165	170	170
Mass consumption of combustion products at maximum heating capacity, kg/sec	0,055	0,086	0,100	0,115
Mass consumption of combustion products at minimum heating capacity, kg/sec	0,024	0,039	0,046	0,054
CO combustion products, mg/m <sup>3</sup>	100	100	100	100
No <sub>x</sub> combustion products, mg/m <sup>3</sup>	200	200	200	200
Coefficient of excess air in combustion products	1,5-1,8	1,5-1,8	1,5-1,8	1,5-1,8
Hydraulic resistance at a temperature drop of 20 °C, MPA	0,025	0,032	0,032	0,032
The maximum temperature of the coolant at the outlet of the boiler, °C	100			
Operating range of the temperature controller, °C	50-95			
Heat exchange area, m <sup>2</sup>	11	16,2	18,3	19,3
Furnace volume, m <sup>3</sup>	0,7	0,12	0,12	0,12
Diameter of the chimney, mm	200	300	350	350
Connection dimensions of the pipe to the gas supply system, inch	1¼"	1¼"	1¼"	1¼"
Connection dimensions of the pipe to the heating system, inch	2"	2"	2"	2"
Parameters of the power supply network, V/Hz	230/50	230/50	230/50	230/50
Electrical power (without additional accessories), W	34	42	51	51
Service life, years	10	10	10	10
Dimensions, mm:				
- height	960***	960***	960***	960***
- width	930	1360	1360	1360
- depth	875	875	875	875
Mass not more than, kg				
- net	145	250	258	260
- gross	163	280	288	290

1 Pa = 0,102 mm of water column

\* - the result was obtained in laboratory conditions

\*\* - the result was obtained by calculation in the laboratory

\*\*\* - without stabilizer thrust





# WALL-HANG GAS BOILERS ELECTRIC BOILERS



**COME IN. CHOOSE. BUY! [LEMAX-BOILER.COM](http://LEMAX-BOILER.COM)**



# WALL-HANG GAS BOILERS OF THE PRIME-V SERIES WITH A CLOSED COMBUSTION CHAMBER

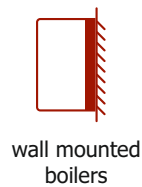

wall mounted  
boilers



combi

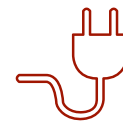

electric  
dependence

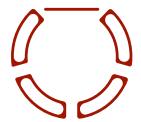

closed combustion  
chamber



copper heat  
exchanger



natural and  
liquefied gas



independent primary  
and secondary  
heat exchanger



3  
years  
warranty



- The model range is from 10 to 32 kW.
- Intuitive operation.
- The maximum length of a coaxial chimney is up to 4,5 m, and a separate chimney is up to 20 m.
- High unification of components and components for all models of Lemax wall boilers of the Prime series.
- Solid heat and sound insulation to ensure acoustic comfort in the conditions of apartment-by-apartment heating.
- The ability to connect the monitoring and control device for monitoring and managing comfort in the home (Android and IOS).
- The increased volume of the combustion chamber ensures complete combustion of gas, increases the service life of the heat exchanger and minimizes gas consumption.
- Double level of safety against excess pressure in the heating circuit, which is provided by a built-in pressure sensor and a relief valve.
- Working in systems with high hydraulic resistance allows in most cases exclude the installation of an additional pump.
- Structurally protected sensors and sensors from corrosion and scale.
- Adapted to gas pressure drops.
- The ability to connect a room thermostat to adjust the temperature inside the room with high accuracy.

## WALL-HANG GAS BOILERS OF THE PRIME-V SERIES WITH A CLOSED COMBUSTION CHAMBER



Coaxial chimney system  
\* not included in the package

- The extended operating voltage range of the boiler allows for stable operation of the boiler in networks with high and low voltage (185 - 245 v).
- Integrated ignition transformer, which ensures stable spark formation and maximum smoothness of ignition.
- An independent heat exchanger of the hot water circuit minimizes the cost of annual maintenance, ensures temperature stability in the hot water circuit and has a longer service life compared to a bitermic heat exchanger.
- Reed flow sensor: the sealed contact detects the presence of a water flow, does not require regular maintenance and ensures that the hot water supply circuit is switched on at a water flow of 2 l/min, off at 1,5 l/min, which allows the use of a hot water circuit in rooms with low water pressure.
- A bypass is installed in the boiler hydrogroup, which protects the boiler elements from overheating when excessive hydraulic resistance appears in the heating system.
- Ease of maintenance of the boiler due to the use of easily removable cladding.

# WALL-HANG GAS BOILERS OF THE PRIME-V SERIES WITH A CLOSED COMBUSTION CHAMBER

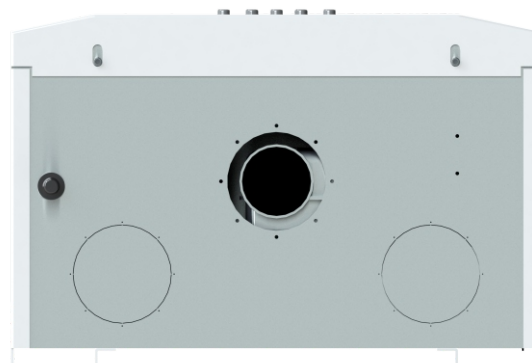

Parameter	Prime-V10	Prime-V12	Prime-V14	Prime-V16	Prime-V18	Prime-V20	Prime-V24	Prime-V26	Prime-V28	Prime-V32
Gas valve	845 SIGMA	845 SIGMA	845 SIGMA	845 SIGMA	845 SIGMA	845 SIGMA	845 SIGMA	845 SIGMA	845 SIGMA	845 SIGMA
Nominal heating capacity in heating mode, kW	10	12	14	16	18	20	24	26	28	32
Minimum heating capacity in heating mode, kW	6	6	6	6	6	9	9	11	11	11
Efficiency, % not less than	92*	92*	92*	92,5*	92,5*	92,5*	92,5*	92,2*	92,2*	92,2*
Approximate area of the heated room, m <sup>2</sup>	100**	120**	140**	160**	180**	200**	240**	260**	280**	320**
Volume of the built-in expansion tank, l	6	6	6	6	6	6	6	8	8	8
Natural gas consumption, m <sup>3</sup> /h: - maximum - average	1,13 0,6***	1,36 0,7***	1,59 0,9***	1,81 1***	2,04 1,2***	2,27 1,3***	2,72 1,4***	2,95 1,5***	3,17 1,7***	3,63 2***
Nominal natural gas pressure, Pa	1300-2000									
Nominal liquefied gas pressure, Pa	2900									
Maximum working pressure of the coolant, MPA	0,3****	0,3****	0,3****	0,3****	0,3****	0,3****	0,3****	0,3****	0,3****	0,3****
Minimum working pressure of the coolant, MPA	0,08*****	0,08*****	0,08*****	0,08*****	0,08*****	0,08*****	0,08*****	0,08*****	0,08*****	0,08*****
Preliminary air pressure in the expansion tank, MPA	0,1	0,1	0,1	0,1	0,1	0,1	0,1	0,1	0,1	0,1
Maximum pressure in the hot water system, MPA	0,8	0,8	0,8	0,8	0,8	0,8	0,8	0,8	0,8	0,8
Specific consumption of hot water at Δt=25°C, l/min	9,7*****	9,7*****	9,7*****	9,7*****	9,7*****	13,1*****	13,1*****	18,1*****	18,1*****	18,1*****
Minimum consumption of hot water, l/min	2 ON 1,5 OFF	2 ON 1,5 OFF	2 ON 1,5 OFF	2 ON 1,5 OFF	2 ON 1,5 OFF	2 ON 1,5 OFF	2 ON 1,5 OFF	2 ON 1,5 OFF	2 ON 1,5 OFF	2 ON 1,5 OFF
Smoke temperature °C, not less than	80	80	80	80	80	80	80	80	80	80
Parameters of the feeding electrical circuit, V/Hz	220/50	220/50	220/50	220/50	220/50	220/50	220/50	220/50	220/50	220/50
Maximum electrical power consumption, W	125	125	125	125	125	125	125	125	125	125
Dimensions, mm - height - width - depth	783 430 268	783 430 268	783 430 268	783 430 268	783 430 268	783 430 268	783 430 268	776 430 340	776 430 340	776 430 340
Weight, kg - net no more - gross	28 31	28 31	28 31	28 31	28 31	28 31	29 32	29 32	32 35	32 35

1 Pa = 0,102 mm of water column

\* - the result was obtained in laboratory conditions

\*\* - the maximum area of the heated room is determined in the project for the heating system, taking into account all heat losses of the building

\*\*\* - the result was obtained by calculation in the laboratory

\*\*\*\* - the pressure sensor is set to a minimum starting pressure of 0,08 MPa, and an error will be displayed on the screen.

After the pressure is normalized, the error will be automatically reset.

\*\*\*\*\* - theoretical water consumption at maximum capacity of the hot water supply circuit

## WALL-HANG GAS BOILERS OF THE PRIME-V HO SERIES WITH A CLOSED COMBUSTION CHAMBER



wall mounted boilers

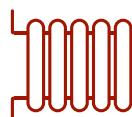

heat only

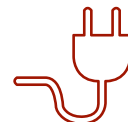

electric dependence

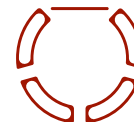

closed combustion chamber



copper heat exchanger



natural and liquefied gas

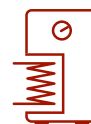

working with an indirect heating tank

**3**  
years

warranty



- The model range - 24 kW, 32 kW.
- Intuitive operation.
- The maximum length of a coaxial chimney is up to 4,5 m, and a separate chimney is up to 20 m.
- High unification of components and components for all models of Lemax wall boilers of the Prime series.
- Solid heat and sound insulation to ensure acoustic comfort in the conditions of apartment-by-apartment heating.
- The ability to connect monitoring and control device for monitoring and managing comfort in the home (Android and IOS).
- The increased volume of the combustion chamber ensures complete combustion of gas, increases the service life of the heat exchanger and minimizes gas consumption.
- Double level of safety against excess pressure in the heating circuit, which is provided by a built-in pressure sensor and a relief valve.
- Working in systems with high hydraulic resistance allows in most cases exclude the installation of an additional pump.
- Structurally protected sensors and sensors from corrosion and scale.
- Adapted to gas pressure drops.
- The ability to connect a room thermostat to adjust the temperature inside the room with high accuracy.



# WALL-HANG GAS BOILERS OF THE PRIME-V HO SERIES WITH A CLOSED COMBUSTION CHAMBER



- The extended operating voltage range of the boiler allows for stable operation of the boiler in networks with high and low voltage (185 - 245 v).
- Integrated ignition transformer, which ensures stable spark formation and maximum smoothness of ignition.
- A bypass is installed in the boiler hydrogroup, which protects the boiler elements from overheating when excessive hydraulic resistance appears in the heating system.
- Ease of maintenance of the boiler due to the use of easily removable cladding.

Parameter	Prime-V20HO	Prime-V24HO	Prime-V26HO	Prime-V28HO	Prime-V32HO
Gas valve	845 SIGMA	845 SIGMA	845 SIGMA	845 SIGMA	845 SIGMA
Nominal heating capacity in heating mode, kW	20	24	26	28	32
Minimum heating capacity in heating mode, kW	9	9	11	11	11
Efficiency, % not less than	92,5*	92,5*	92,2*	92,2*	92,2*
Approximate area of the heated room, m <sup>2</sup>	200**	240**	260**	280**	320**
Volume of the built-in expansion tank, l	6	6	8	8	8
Natural gas consumption, m <sup>3</sup> /h:					
- maximum	2,27	2,72	2,95	3,18	3,63
- average	1,3***	1,4***	1,5***	1,7***	2***
Nominal natural gas pressure, Pa	1300-2000				
Nominal liquefied gas pressure, Pa	2900				
Maximum working pressure of the coolant, MPA	0,3****	0,3****	0,3****	0,3****	0,3****
Minimum working pressure of the coolant, MPA	0,08*****	0,08*****	0,08*****	0,08*****	0,08*****
Preliminary air pressure in the expansion tank, MPA	0,1	0,1	0,1	0,1	0,1
Smoke temperature °C, not less than	80	80	80	80	80
Parameters of the feeding electrical circuit, V/Hz	220/50	220/50	220/50	220/50	220/50
Maximum electrical power consumption, W	125	125	125	125	125
Dimensions, mm					
- height	770	770	770	770	770
- width	430	430	430	430	430
- depth	268	268	340	340	340
Weight, kg					
- net	29	29	32	32	32
- gross	32	32	35	35	35

1 Pa = 0,102 mm of water column

\* - the result was obtained in laboratory conditions

\*\* - the maximum area of the heated room is determined in the project for the heating system, taking into account all heat losses of the building

\*\*\* - the result was obtained by calculation in the laboratory

\*\*\*\* - the pressure sensor is set to a minimum starting pressure of 0,08 MPa, and an error will be displayed on the screen.

After the pressure is normalized, the error will be automatically reset.

\*\*\*\*\* - theoretical water consumption at maximum capacity of the hot water supply circuit

## WALL-HANG GAS BOILERS OF THE PRIME-V HO SERIES WITH A CLOSED COMBUSTION CHAMBER

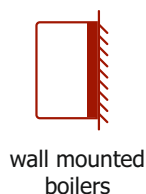
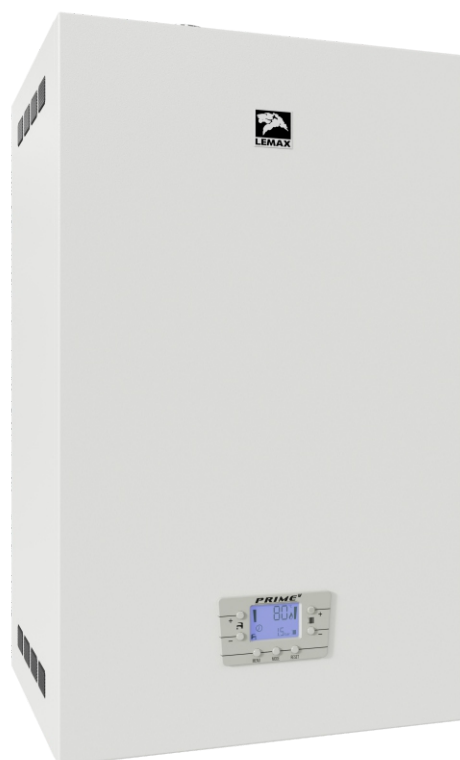

- The model is 55 kW.
- The maximum length of a separate chimney is up to 20 m.
- The optimal volume of the combustion chamber ensures complete combustion of the gas, increases the service life of the heat exchanger and minimizes gas consumption.
- The ability to connect a room thermostat to adjust the indoor temperature with high accuracy.
- Working with a monitoring and control device for remote monitoring and control of gas boilers and heating system indicators by connecting via a potential-free (relay) type of contacts.
- Adapted to gas pressure fluctuations.
- Double level of over-pressure protection in the heating circuit, which is provided by an integrated pressure sensor and a relief valve.
- Working in systems with high hydraulic resistance makes it possible in most cases to exclude the installation of an additional pump.
- Structurally protected sensors and sensors from corrosion and scale.
- The integrated ignition transformer ensures ignition stability and reliability.
- The water pressure indicator on the LCD display provides convenient water pressure monitoring.
- An energy-efficient pump with increased performance.
- Integrated three-way valve.
- Ease of maintenance of the boiler due to the use of easily removable cladding.

## WALL-HANG GAS BOILERS OF THE PRIME-V HO SERIES WITH A CLOSED COMBUSTION CHAMBER

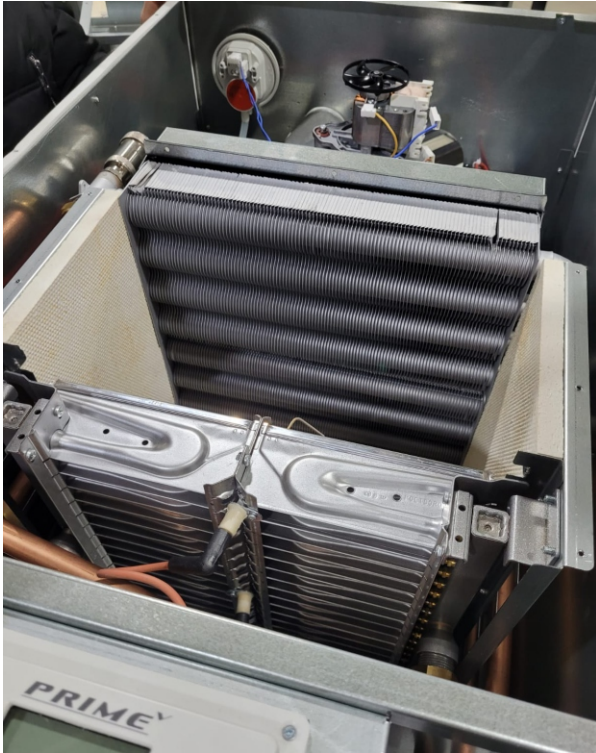

- The combustion chamber and the gas burner are optimized to extend the service life in industrial conditions.



- Cast iron hydraulic collector of the boiler circulation pump.

# WALL-HANG CONDENSATION BOILERS OF THE PRIME-C SERIES WITH A CLOSED COMBUSTION CHAMBER

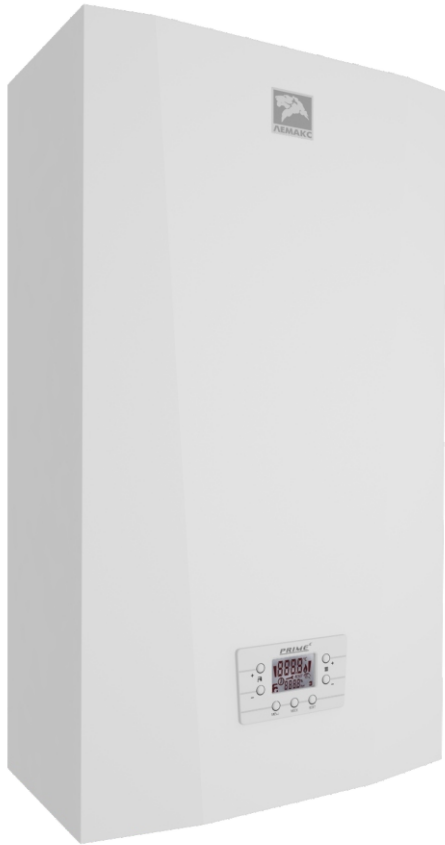

wall mounted boilers



combi

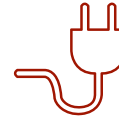

electric dependence

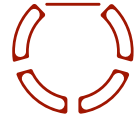

closed combustion chamber



stainless steel heat exchanger



natural and liquefied gas



independent primary and secondary heat exchanger



warranty



- The model range is 24 kW.
- The heat exchanger made of stainless steel Aisi 316.
- The highest degree of modulation 1:10 allows the boiler to be used in heating systems of small rooms, while maintaining the performance of the hot water circuit.
- Built-in weather-dependent automation ensures precise adjustment of equipment to external conditions in the presence of external sensors.
- The sound- and heat-insulated housing reduces background noise and contributes to heat preservation.
- The ability to connect monitoring and control device for monitoring and managing comfort in the home (Android and IOS).
- The combustion chamber, equipped with a burner with the Premix system, ensures maximum completeness of the combustion of the gas-air mixture and minimizes gas consumption.
- The main heat exchanger with a built-in economizer allows you to optimize gas consumption regardless of the operating mode of the boiler.
- Built-in siphon for collecting condensate.
- A pump that circulates water in the system.
- The ability to connect a room thermostat to adjust the temperature inside the room with high accuracy.

## WALL-HANG CONDENSATION BOILERS OF THE PRIME-C SERIES WITH A CLOSED COMBUSTION CHAMBER

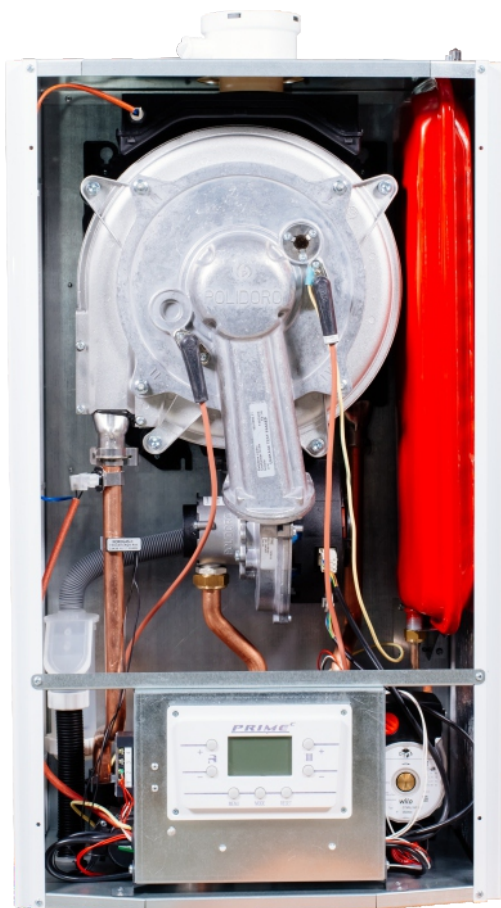

- Double level of protection against excess pressure in the heating circuit, which is provided by a built-in pressure sensor and a relief valve.
- Working in systems with high hydraulic resistance makes it possible in most cases to exclude the installation of an additional pump.
- Structurally protected sensors and sensors from corrosion and scale.
- The extended operating voltage range of the boiler allows for stable operation of the boiler in networks with high and low voltage (185 - 245 v).
- The integrated ignition transformer ensures stable spark formation and maximum smoothness of ignition.
- The water pressure indicator on the LCD display provides convenient water pressure monitoring.

- The independent heat exchanger of the hot water supply circuit minimizes the cost of annual maintenance, ensures temperature stability in the hot water circuit and has a longer service life compared to a bitermic heat exchanger.
- Reed flow sensor: the sealed contact detects the presence of a water flow, does not require regular maintenance and ensures that the hot water supply circuit is switched on at a water flow of 2 l/min, off at 1,5 l/min, which allows the use of a hot water supply circuit in rooms with low water pressure.
- A bypass is installed in the collector group of the boiler, which protects the boiler elements from overheating when excessive hydraulic resistance appears in the heating system or when the coolant is blocked.
- Ease of maintenance of the boiler due to the use of easily removable cladding.

# WALL-HANG CONDENSATION BOILERS OF THE PRIME-C SERIES WITH A CLOSED COMBUSTION CHAMBER



Parameter	Prime-C24
Gas valve	845 SIGMA
Nominal heating capacity in heating mode 80/60, kW	24
Minimum heating capacity in heating mode 80/60, kW	2,6
Nominal heating capacity in heating mode 50/30, kW	26,4
Minimum heating capacity in heating mode 50/30, kW	2,85
The efficiency of the lowest heat of combustion	108*
Approximate area of the heated room, m <sup>2</sup>	240**
Volume of the built-in expansion tank, l	6
Nominal natural gas pressure, Pa	1300-2000
Nominal liquefied gas pressure, Pa	2900
Maximum working pressure of the coolant, MPA	0,28***
Minimum working pressure of the coolant, MPA	0,08****
Preliminary air pressure in the expansion tank, MPA	0,1
Maximum pressure in the hot water system, MPA	0,8
Specific consumption of hot water at $\Delta t=25^{\circ}\text{C}$ , l/min	16*****
Minimum consumption of hot water, l/min	2 ON 1,5 OFF
Smoke temperature $^{\circ}\text{C}$ , not less than	75
Smoke limit temperature $^{\circ}\text{C}$ , not less than	105
Parameters of the feeding electrical circuit, V/Hz	220/50
Maximum electrical power consumption, W	175
Dimensions, mm - height	770
- width	430
- depth	268
Weight, kg - net	31
- gross	33

1 Pa = 0,102 mm of water column

\* - the result was obtained in laboratory conditions

\*\* - the maximum area of the heated room is determined in the project for the heating system, taking into account all heat losses of the building

\*\*\* - the result was obtained by calculation in the laboratory

\*\*\*\* - the pressure sensor is set to a minimum starting pressure of 0,08 MPa, and an error will be displayed on the screen.

After the pressure is normalized, the error will be automatically reset.

\*\*\*\*\* - theoretical water consumption at maximum capacity of the hot water supply circuit



# WALL-HANG GAS BOILERS OF THE PRIME-MA SERIES WITH AN OPEN COMBUSTION CHAMBER

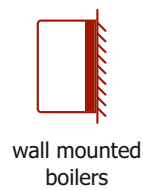

wall mounted  
boilers



combi

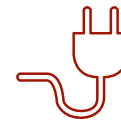

electric  
dependence



open combustion  
chamber



copper heat  
exchanger



natural and  
liquefied gas



independent primary  
and secondary  
heat exchanger



years

warranty



- The model range - 24 kW.
- The independent heat exchanger of the hot water supply circuit minimizes the cost of annual maintenance, ensures temperature stability in the hot water circuit and has a longer service life compared to a bitermic heat exchanger.
- A high level of unification of components and components for all models of Lemax wall boilers.
- The ability to connect monitoring and control device for monitoring and managing comfort in the home (Android and IOS).
- The increased volume of the combustion chamber ensures complete combustion of the gas and increases the service life of the heat exchanger.
- Double level of protection against excess pressure in the heating circuit, which is provided by a built-in pressure sensor and a relief valve.
- Working in systems with high hydraulic resistance makes it possible in most cases to exclude the installation of an additional pump.
- Structurally protected sensors and sensors from corrosion and scale.
- The extended operating voltage range of the boiler allows for stable operation of the boiler in networks with high and low voltage (185 - 245 v).
- The integrated ignition transformer ensures stable spark formation and maximum smoothness of ignition.
- The water pressure indicator on the LCD display provides convenient water pressure monitoring.
- The ability to connect a room thermostat to adjust the temperature inside the room with high accuracy.

# WALL-HANG GAS BOILERS OF THE PRIME-MA SERIES WITH AN OPEN COMBUSTION CHAMBER

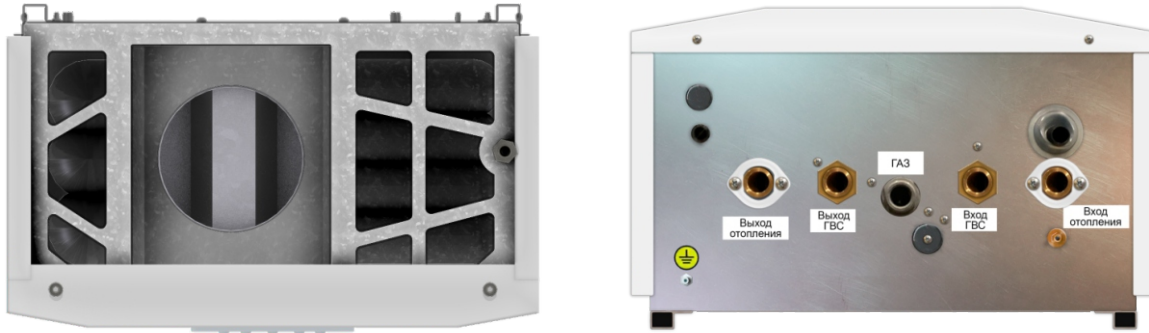

- Reed flow sensor: the sealed contact detects the presence of a water flow, does not require regular maintenance and ensures that the hot water supply circuit is switched on at a water flow of 2 l/min, off at 1,5 l/min, which allows the use of a hot water circuit in rooms with low water pressure.
- A bypass is installed in the collector group of the boiler, which protects the boiler elements from overheating when excessive hydraulic resistance appears in the heating system or when the coolant is blocked.
- Ease of maintenance of the boiler due to the use of an easily removable top panel.

Parameter	Prime-MA24
Gas valve	845 SIGMA
Nominal heating capacity in heating mode, kW	23,4
Minimum heating capacity in heating mode, kW	9,8
Efficiency, % not less than	92,5*
Approximate area of the heated room, m <sup>2</sup>	240**
Volume of the built-in expansion tank, l	6
Natural gas maximum consumption, m <sup>3</sup> /h:	2,67
Nominal natural gas pressure, Pa	1300-2000
Nominal liquefied gas pressure, Pa	2900
Maximum working pressure of the coolant, MPA	0,3****
Minimum working pressure of the coolant, MPA	0,08*****
Preliminary air pressure in the expansion tank, MPA	0,1
Maximum pressure in the hot water system, MPa	0,8
Specific consumption of hot water at $\Delta t=25^{\circ}\text{C}$ , l/min	12,9*****
Minimum consumption of hot water, l/min	2 ON 1,5 OFF
Smoke temperature $^{\circ}\text{C}$ , not less than	80
Parameters of the feeding electrical circuit, V/Hz	230/50
Maximum electrical power consumption, W	89
Dimensions, mm	
- height	770
- width	430
- depth	268
Weight, kg no more	
- net	28
- gross	31

1 Pa = 0,102 mm of water column

\* - the result was obtained in laboratory conditions

\*\* - the maximum area of the heated room is determined in the project for the heating system, taking into account all heat losses of the building

\*\*\* - the result was obtained by calculation in the laboratory

\*\*\*\* - the pressure sensor is set to a minimum starting pressure of 0,08 MPa, and an error will be displayed on the screen. After the pressure is normalized, the error will be automatically reset.

\*\*\*\*\* - theoretical water consumption at maximum capacity of the hot water supply circuit

# ELECTRIC BOILERS OF THE PROPLUS SERIES

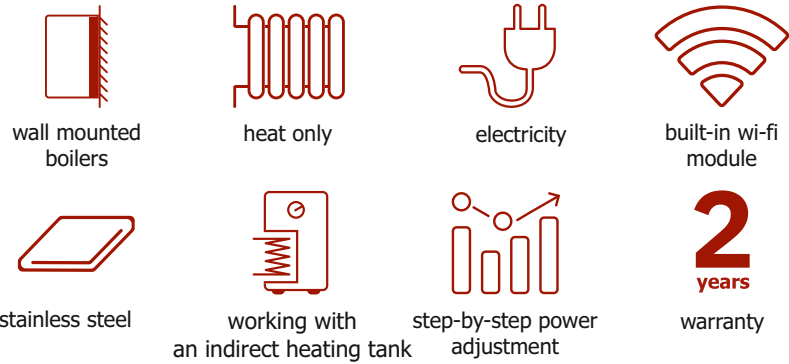
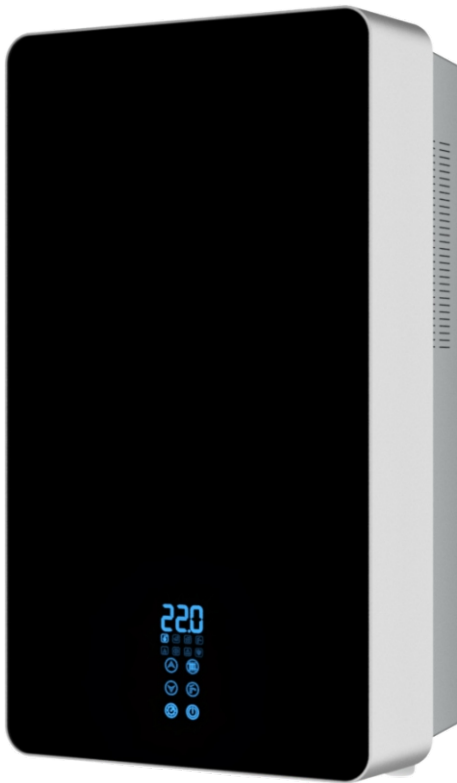

- LEMAX boilers of the PROPLUS series are made in a stylish modern design. These are heating element boilers designed as a universal heat source for heating residential and office premises.
- The model range is from 4,5 to 24 kW.
- 99% efficiency ensures high efficiency when using the equipment.
- Built-in expansion tank of the Italian brand CIMM.
- Structurally built-in sensors: indirect heating tank temperature sensor (indirect heating tank), indoor air temperature sensor.
- The possibility of connecting an indirect heating tank (indirect heating tank).
- Protection against pump blockage.
- Antibacterial protection against legionella formation.
- Protection against freezing of the coolant.
- Energy-efficient pump with frequency control.
- Rotation of heating elements.
- Mobile application (Android and iOS).
- Instant notification of the owner via the mobile application in case of a boiler malfunction.
- The possibility of receiving feedback from the owner about the operation of the boiler.
- Built-in Wi-Fi module for remote monitoring and control of boiler and heating system indicators using a mobile application.
- Programming the air temperature or the temperature in the heating system for the week ahead.
- Possibility to choose the boiler power.
- Working in offline mode allows you to set the temperature regime in the room.
- Control of all boiler functions on the TOUCH SCREEN panel.
- Protection of the user from current leakage: each boiler model is equipped with equipment that turns off the supply of electricity to the boiler when a current leak is detected.
- Protection against freezing of the boiler: when reaching 5°C and below, the heating elements are automatically switched on in the boiler and the coolant is heated to a temperature of 30°C.
- Protection against overheating of the boiler: The boiler heating elements are automatically switched off when the coolant temperature reaches 110°C.
- The easy-to-remove front panel allows maintenance of the boiler without dismantling it from the heating system.

## EUROPEAN QUALITY



Country of manufacture:  
Hungary

## ELECTRIC BOILERS OF THE PROPLUS SERIES

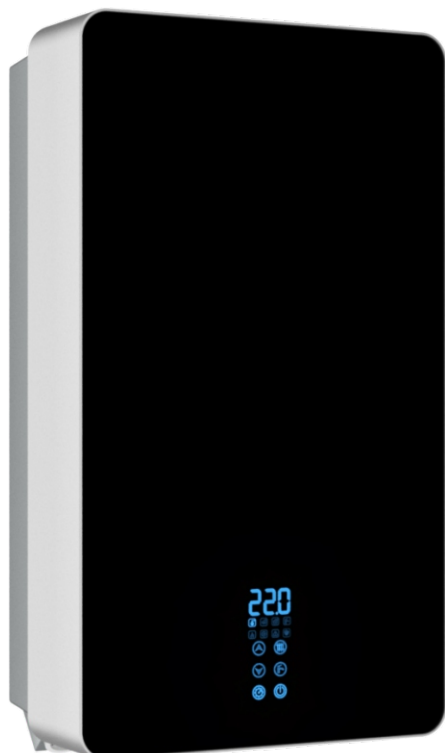

- The ability to use the «priority consumer» function.
- Two types of temperature control: temperature control can be carried out both by the temperature of the water in the heating system and by the temperature in the room.
- The possibility of connecting a room thermostat to adjust the temperature inside the room with high accuracy.
- Low-noise power relay: the boiler uses a noise-insulating housing, due to which the sound level is significantly reduced when the heating degree is turned on.
- Locking the control panel from children: 20 seconds after the boiler use session, the boiler control panel goes into sleep mode, which makes it impossible to accidentally press the control buttons on the panel.
- Saving the set settings in case of an arbitrary power outage: in case of termination and subsequent resumption of power supply, the boiler turns on with the last saved settings.

Parameter	PROPLUS-4,5	PROPLUS-6	PROPLUS-7,5	PROPLUS-9	PROPLUS-12	PROPLUS-15	PROPLUS-18	PROPLUS-21	PROPLUS-24
Power consumption, kW	4,5	6	7,5	9	12	15	18	21	24
Power at the I stage, kW	0,75	1	1,25	1,5	2	2,5	3	2,3	2,6
Power at the II stage, kW	1,5	2	2,5	3	4	5	6	4,6	5,2
Power at the III stage, kW	2,25	3	3,75	4,5	6	7,5	9	6,9	7,8
Power at the IV stage, kW	3	4	5	6	8	10	12	9,2	10,4
Power at the V stage, kW	3,75	5	6,25	7,5	10	12,5	15	11,5	13
Power at the VI stage, kW	4,5	6	7,5	9	12	15	18	13,8	15,6
Power at the VII stage, kW	-	-	-	-	-	-	-	16,1	18,2
Power at the VIII stage, kW	-	-	-	-	-	-	-	18,4	20,8
Power at the IX stage, kW	-	-	-	-	-	-	-	20,7	23,4
Efficiency, % not less than	99								
Rated voltage, V. +10%	220/380	220/380	220/380	380	380	380	380	380	380
Rated current (maximum), A. +10%	3x7/1x20,5	3x9/1x27	3x11/1x34	3x13	3x17,7	3x22	3x26	3x31	3x35
Rated current frequency, Hz	50								
Maximum water temperature, °C	80								
Maximum operating water pressure in the heating system, MPA	3								
Working water pressure in the heating system, MPA	0,5-1,5								
Cable cross section (CU copper), mm <sup>2</sup>	5x1,5/3x4	5x2/3x4	5x2,5/3x6	5x2,5	5x4	5x6	5x6	5x6	5x8
Cable cross section (AL allumenius), mm <sup>2</sup>	5x2,5/3x6	5x2,5/3x10	3x10/5x4	5x4	5x6	5x8	5x10	5x10	5x12
Water temperature regulation, °C range	electronic, от 30°C до 80°C								
Air temperature regulation, °C range	electronic, от 10°C до 40°C								
Regulation of the water temperature in the hot water tank, °C	electronic, от 30°C до 60°C								
Pump power, W	3-43								
Operating temperature of the emergency overheating thermostat, °C	+105								
Minimum water flow through the boiler, l/min	3,7								
Minimum water flow through the boiler, l/min	6								
Size of connecting pipes: cold return water inlet	G3/4								
Expansion tank volume, l	G3/4								
Dimensions, mm									
- height	744								
- width	375								
- depth	248								
Weight, kg	23				24				



# GAS WATER HEATERS



**COME IN. CHOOSE. BUY! [LEMAX-BOILER.COM](http://LEMAX-BOILER.COM)**





# GAS WATER HEATER LMX MODEL 20M

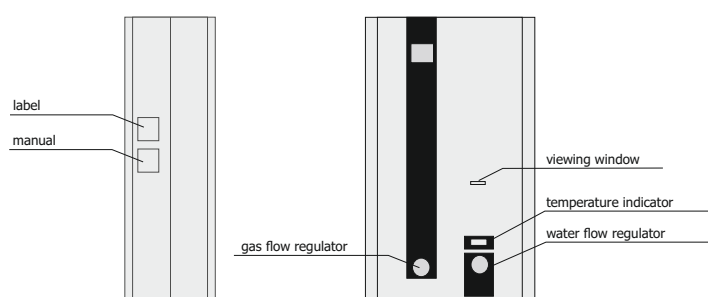
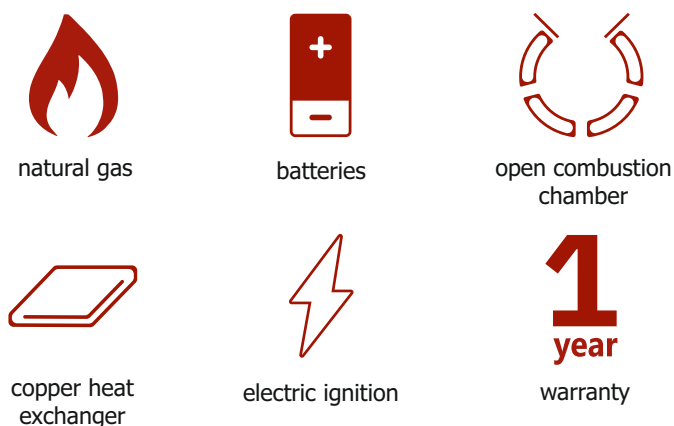
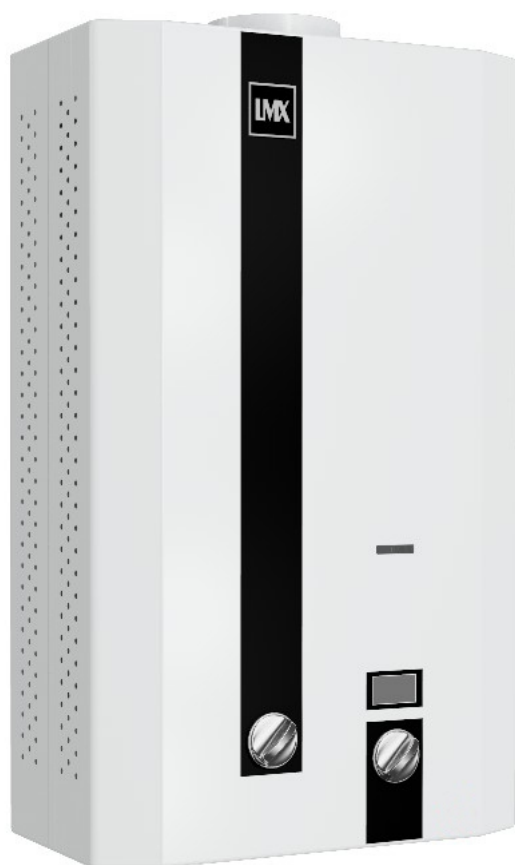

- Original design of the front panel and compact dimensions.
- The device operates at a water pressure of 0,25 atm in the system: it is optimal for users living on upper floors or having low water pressure.
- Automatic ignition of the burner by a stream of water in the absence of a working igniter eliminates gas overspending.
- Ion flame control: when the burner goes out, it automatically turns off the gas supply.
- Protection against dry burning: when the device is turned on without water flow, the protection device will automatically turn off the gas supply.

Parameter	The value of the indicator
Rated thermal power, kW	20
Nominal pressure of natural gas, Pa	1300
Nominal consumption of natural gas, m <sup>3</sup> /h	2,76
Efficiency, % not less	84
The pressure of the conducted water for the normal operation of the device, atm	0,2-6
Minimum water flow (for ignition), l/min	2,5
Water consumption when heated at t=25°C, l/min	10
The ignition of the device is automatic	+
Dimensions (height/ width /depth), mm no more	600/345/175
Weight, kg no more	10

# GAS WATER HEATER LMX MODELS CLASSIC-20/24/32



natural gas

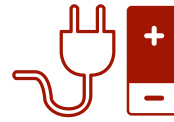

adapter to the boiler  
220 V/ batteries



open combustion  
chamber



copper heat  
exchanger



electric ignition



warranty

- The original design of the front panel.
- Work in automatic mode.
- Copper heat exchanger (oxygen-free copper) provides fast heating of water and a long service life.
- The device operates at a water pressure of 0,15 atm: it is optimal for users living on upper floors or having low water pressure.
- Ion flame control: when the burner goes out, it automatically turns off the gas supply.
- Protection against dry burning: when the device is turned on without water flow, the device will automatically turn off the gas supply.

**oxygen-free copper**

**open combustion  
chamber**

**up to 3 water  
sampling points**

\* 1 water sampling point - Classic-20,  
2 water sampling points - Classic-24,  
3 water sampling points - Classic-32.

Parameter	The value of the indicator		
	Classic-20	Classic-24	Classic-32
<b>Model</b>			
Type of combustion chamber	open	open	open
Rated thermal power, kW	20	24	32
Minimum thermal power, kW	10	12	16
Rated heating capacity, kW	16,8	20,2	26,9
Minimum heating capacity, kW	8,4	10,1	13,5
Nominal pressure of natural gas, Pa	1274	1274	1274
Nominal consumption of natural gas, m3/h	2,32	2,78	3,71
Efficiency, % not less	84	84	84
The pressure of the conducted water for the normal operation of the device, atm	0,2-6	0,2-6	0,2-6
Minimum water flow (for ignition), l/min	2,5	2,5	2,5
The ignition time of the device in the cold state / in steady-state operation, sec	9/9	9/9	9/9
Water consumption at t=25°C, l/min	10	12	16
Smoke temperature, °C not less than	110	110	110
The ignition of the device is automatic	yes	yes	yes
Flame modulation	yes	yes	yes
Diameter of the gas pipe, inch	1/2"	1/2"	1/2"
Diameter of the water pipe, inch	1/2"	1/2"	1/2"
Chimney connection diameter, inch	115-120	115-120	130-135
Electrical network parameters, V/Hz	~110-240/50	~110-240/50	~110-240/50
Electrical power consumption, W	2	2	2
Dimensions (h/w/d), mm no more	550/330/188	610/350/188	700/440/205
Weight, kg no more	8,6/9,7	9,6/11,2	13,2/15,2

# GAS WATER HEATER LMX MODELS TURBO-24/BALANCE-24



natural gas

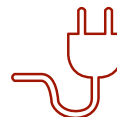

220 V

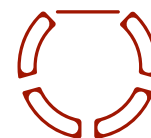

closed combustion chamber



copper heat exchanger



electric ignition

**1**  
year

warranty

- The model with a multi-level control system provides the maximum level of safety and comfort.
- Air intake and smoke extraction systems allow you to install the device regardless of the location of the vent channel or chimney (in coordination with the gas industry at the place of installation of the equipment).
- Modern ergonomic design with an intelligent touch control display, with which you can maintain and monitor the temperature of water heating.
- The microprocessor control system ensures a constant water temperature at the outlet by using the modulation mode.
- Ion flame control: when the burner goes out, it automatically turns off the gas supply.
- Protection against dry burning: when the device is turned on without water flow, the device will automatically turn off the gas supply.

**microprocessor control system**

**closed combustion chamber**

**2 water sampling points**

Parameter	The value of the indicator	
	Turbo-24	Balance-24
<b>Model</b>		
Rated thermal power, kW	24	24
Nominal pressure of natural gas, Pa	1274	1274
Nominal consumption of natural gas, m <sup>3</sup> /h	2,78	2,78
Efficiency, % not less	84	84
The pressure of the conducted water for the normal operation of the device, atm	0,2-6	0,2-6
Minimum water flow (for ignition), l/min	2,5	2,5
Water consumption when heated at t=25°C, l/min	12	12
Smoke temperature, °C not less than	110	110
The ignition of the device is automatic	+	+
Flame modulation	+	+
Diameter of the gas pipe, inch	1/2"	1/2"
Diameter of the water pipe, inch	1/2"	1/2"
Coaxial chimney	-	+
Chimney connection diameter, inch	60	60/100
Electrical power consumption, W	40	40
Dimensions (height/ width /depth), mm no more	560/350/106	560/350/106
Weight, kg no more	11	13





## RELATED PRODUCTS



COME IN. CHOOSE. BUY! [LEMAX-BOILER.COM](http://LEMAX-BOILER.COM)





# EXTERNAL FAN OF THE COMFORT AND COMFORT SE SERIES MODELS S, M, L



External Fan Lemax is a device that provides forced removal of combustion products. The installation of an External Fan will eliminate the organization of a stationary chimney and can be an ideal solution in conditions when the installation of a chimney is difficult or impossible.

It works in conjunction with Lemax single-circuit and double-circuit boilers equipped with safety automation 820 NOVA, Prestige, Uno, Omega, Classic 35-40 kW, Premium N, Perfect, gas heating devices of the Premier series (Comfort SE series) or boilers with safety automation 845 SIGMA, CLEVER, Omega E, WISE series (Comfort series).



**S**

**M**

**L**

## COMFORT SE SERIES

for electric independent boilers

- External Fan
- Connection Kit
- Electronic Control Unit



**L**

## COMFORT SERIES

for electric dependence boilers

- External Fan
- Connection Kit

Type of heat exchanger		Стальной теплообменник				Чугунный теплообменник			
Nominal heating capacity of the boiler		7,5 - 10 kW	12,5 - 16 kW	20 - 30 kW	35 - 40 kW	16 kW	25 kW	35 kW	40 kW
Dependence on an external power source	Electric independence boiler	Comfort SE (S)	Comfort SE (M)	Comfort SE (L)	Comfort SE (L140)	Comfort SE (L)		Comfort SE (L140)	
	Electric dependence boiler	—	—	Comfort (L)	Comfort (L140)	Comfort (L)		Comfort (L140)	
The vacuum created by the prefix, at the outlet of the boiler, Pa		5 - 8	5 - 12	5 - 12	5 - 12	5 - 12	5 - 12	5 - 12	5 - 12
Pressure at the outlet of the prefix, Pa		40-70	40-70	40-70	40-70	40-70	40-70	40-70	40-70
Diameter of the chimney, mm		100	130	130	140	130	130	140	140
Diameter of the discharge pipe, mm		80	80	80	80	80	80	80	80
The diameter of the throttle ring on the outlet pipe, mm		—	—	—	—	39*	47*	49*	—
Rated voltage of the power grid, V		230	230	230	230	230	230	230	230
Rated current frequency, Hz		50	50	50	50	50	50	50	50
Noise, Decibel not less than		50	50	50	50	50	50	50	50
Electrical power consumption, W not less than		40	40	40	40	40	40	40	40
Net weight, kg		$\frac{3,5^*}{3,3}$	$\frac{3,5^*}{3,3}$	$\frac{3,5^*}{3,3}$	$\frac{3,5^*}{3,3}$	$\frac{3,5^*}{3,3}$	$\frac{3,5^*}{3,3}$	$\frac{3,5^*}{3,3}$	$\frac{3,5^*}{3,3}$
Gross weight, kg		$\frac{3,7^*}{3,5}$	$\frac{3,7^*}{3,5}$	$\frac{3,7^*}{3,5}$	$\frac{3,7^*}{3,5}$	$\frac{3,7^*}{3,5}$	$\frac{3,7^*}{3,5}$	$\frac{3,7^*}{3,5}$	$\frac{3,7^*}{3,5}$

\* - in the numerator, the mass of the Comfort SE series External Fan; in the denominator, the Comfort series External Fan.

# EXTERNAL FAN OF THE COMFORT AND COMFORT SE SERIES MODELS XL, XXL



External Fan of the Comfort SE and Comfort models XL and XXL series are designed for forced discharge of combustion products of Lemax boilers with a capacity from 50 kW to 60 kW.

The devices work together with electric independent single-circuit and double-circuit boilers and Lemax heating devices equipped with SIT 820 NOVA safety automation and having a steel heat exchanger: Prestige, Uno, Omega, Premium N, Perfect, Classic, Premier - Comfort SE series models XL and XXL. And also with electric dependence boilers with safety automation SIT 845 SIGMA of the CLEVER, Omega E series - External Fan of the Comfort series of XXL models.



## COMFORT SE SERIES

for electric independent boilers

- External Fan
- Connection Kit
- Electronic Control Unit

## COMFORT SERIES

for electric dependence boilers

- External Fan
- Connection Kit

Type of heat exchanger		Steel heat exchanger	
Nominal heating capacity of the boiler		50 kW	60 kW
Dependence on an external power source	Electric independence boiler	Comfort SE (XL)	Comfort SE (XXL)
	Electric dependence boiler	Comfort (XL)	Comfort (XXL)
The vacuum created by the prefix, at the outlet of the boiler, Pa		5	5
Pressure at the outlet of the prefix, Pa		Not less than 22	
Diameter of the chimney, mm		200	200
Diameter of the discharge pipe, mm		100	100
The diameter of the throttle ring on the outlet pipe, mm		–	–
Rated voltage of the power grid, V		230	230
Rated current frequency, Hz		50	50
Noise, Decibel not less than		50	50
Electrical power consumption, W not less than		82	82
Net weight, kg		$\frac{6,3^*}{6,1}$	$\frac{6,3^*}{6,1}$
Gross weight, kg		$\frac{7,3^*}{7,1}$	$\frac{7,3^*}{7,1}$

\* - in the numerator, the mass of the Comfort SE series External Fan; in the denominator, the Comfort series External Fan.

## EXTERNAL FAN OF THE COMFORT SERIES MODELS COMFORT 150, COMFORT 180



External Fans are devices that provide forced removal of combustion products. The installation of a External Fan eliminates the organization of a stationary chimney and can be an ideal solution in conditions when the installation of a chimney is difficult or impossible.

External Fans Lemax of the Comfort series of Comfort 150 and Comfort 180 models work together with CLEVER L150 and CLEVER L180 floor boilers, respectively. The devices support a two-stage operation mode of the gas burner device and are controlled by the electronics of the heating equipment. External Fans models Comfort 150, Comfort 180 best reveal the capabilities of boilers of the CLEVER L series with a multi-valve modular burner.



Parameter	Comfort 150	Comfort 180
Boiler compatibility	CLEVER L150	CLEVER L180
Nominal heating capacity of the boiler	150 kW	180 kW
Useful overpressure, Pa	80	
The diameter of the clamp at the entrance, mm	300	350
The diameter of the clamp at the exit, mm	249 <sub>2</sub>	
Smoke temperature, °C	200	
Rated voltage of the power grid, V	230	
Rated current frequency, Hz	50	
Noise, Decibel not less than	80	
Electrical power consumption, W not less than	164	
Net/gross weight, kg	16,6/17,4	

## RELATED PRODUCTS



### ROOM THERMOSTAT CEWAL (Italy)



This thermostat is used for automatic temperature control in heating systems in various rooms - houses, hotels, schools, offices, factories. Ideal for Lemax boilers and heating devices with 820 NOVA SIT safety automation, energy-dependent boilers with 845 SIGMA safety automation, as well as Lemax electric boilers up to 220 V.

It is advisable to choose a place for the thermostat in the zone where the average temperature of the entire room is maintained. Avoid the proximity of doors, windows, heat sources, as well as positions with excess or with a complete lack of aeration. In addition, it is advisable to install the thermostat at about 1,5 m from the floor.

### CORROSION INHIBITOR

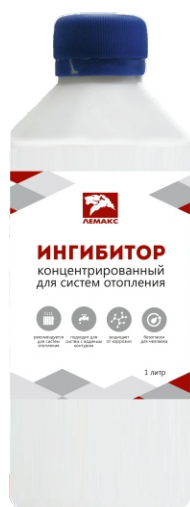

The concentrate is a mixture of various corrosion inhibitors with complexing agents that effectively prevent corrosion of ferrous and non-ferrous metals and the formation of scale in heating systems. It works confidently in water with a hardness of up to 12 mg-eq/l.

The inhibitor is also used for the preservation of metal products, elements of heating systems, during long-term storage forming a protective film that protects the products from subsequent corrosion. The inhibitor does not change the crystallization temperature of the water.



**Dream. Believe. Love.  
Make Happy. Create Kindness.**



## **WHAT ARE WE?**

- Your reliable Partner
- The leader of the Russian market in the field of domestic heating equipment
- Manufacturing and trading company of federal level

## **WHAT DO WE MAKE?**

Heating Equipment:

- Steel Floor-Standing Gas Boilers
- Iron Floor-Standing Gas Boilers
- Wall-Hang Gas Boilers
- Electric Boilers
- Gas Water Heaters
- Steel Water-Heating Boilers
- External Fans and other related products
- Steel Panel Radiators

## **WHY WITH US?**

- Multifunctional metalworking complex
- Robotic welding
- Automated powder coating line
- Original Italian components
- Authorized service centers throughout Russia

## **HOW TO FIND US?**

- Visit us [lemax-boiler.com](http://lemax-boiler.com)
- Call us +7 8634 312 345
- Write us [info@lemax-kotel.ru](mailto:info@lemax-kotel.ru)

**LIKE IT?**



**SHARE!**